



# FARRIER

# CATALOGUE

2019 - 2020

# FARRIER CATALOGUE

2019 - 2020

We have been farriers and have a solid understanding of most of the products we stock. If you need help or advice about a product then please ask.

If there's something you need that is not listed in this catalogue then there's a chance we might have it anyway or can source it for you. We import and distribute farrier and hoofcare products from all over the world.

## WAREHOUSE



The physical store is open 9am to 5pm Monday to Friday excluding holidays for visitors (out of hours visits by prior arrangement). We are contactable via text, phone, or web, any time.

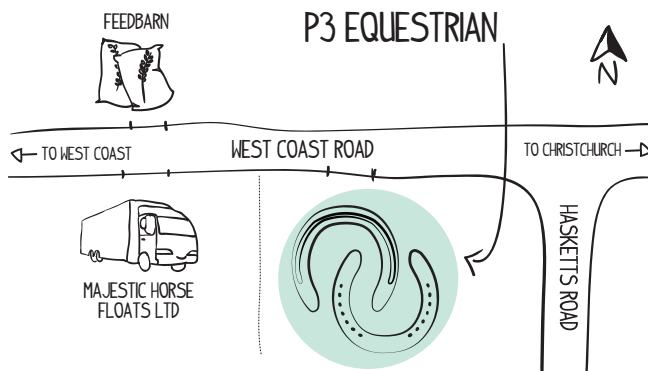

We are located at:

**115 West Coast Road, Yaldhurst, Christchurch 7676, New Zealand**



## CONTACT US

---

Tel: 0800 211 212 (New Zealand)

Email: [sales@p3equestrian.com](mailto:sales@p3equestrian.com)

Tel: 1800 195 088 (Australia)

Shop online: [www.farrier-shop.com](http://www.farrier-shop.com)

Dave: +64 21 555 213

115 West Coast Road, Yaldhurst,  
Christchurch 7676, New Zealand

Facebook: [www.facebook.com/farriershop](http://www.facebook.com/farriershop)

## MAILING ADDRESS

---



P3 Equestrian Limited, PO Box 4558,  
Christchurch 8140, New Zealand

## SHIPPING

---



We specialise in mail order.

Target delivery for North or South Island orders is the next working day (2-3 days for bulky items and some rural addresses) for in-stock items.

Saturday deliveries are sometimes available for an extra charge depending on location.

We ship daily to the North and South Islands and to Australia. We regularly ship to other international locations.

## PAYMENT

---



We accept payment by direct credit, Visa, MasterCard, AMEX, cash and EFTPOS.

# CONTENTS

<b>Horseshoes</b>	<b>1</b>
Riding Shoes	3
Pony Shoes	12
Heavy Horseshoes	14
Racing Shoes	15
Aluminium Shoes	18
Harness Shoes	27
Barshoes	37
Specialist Shoes	48
Bar Stock	59



<b>Nails</b>	<b>61</b>
--------------	-----------



<b>Foot Tools</b>	<b>68</b>
Hoof Nippers	69
Half Round Nippers	72
Nail Cutters	72
Knives	73
Knife Sharpeners	78
Rasps	79
Rasp Covers	84
Sanding Rasps	85
Rasp Handles	86
Hoof Buffers	87
Clench Cutters and Buffers	87
Wire Brushes	88
Pull-Offs	89
Nail Pullers	90
Nailing-On Hammers	91
Hammer Handles	92
Clenchers	93
Clenching Blocks/Groovers	95
Other Hoof Tools	96
Tool Boxes	99
Hoof Stands	101
Measuring	103



<b>Forging Tools</b>	<b>104</b>
Forging Hammers	105
Fullers	106



Stamps	107
Pritchels	107
Stud Punches	108
Taps	109
Fire Tongs	110
Other Forge Tools	111
Flux	112
Anvils	112
Anvil Stands	116
Forges	117
Forge Parts	119
Vices	121

## **Hoof Care** **122**

Hoof Adhesives and Applicators	123
Silicones and Applicators	129
Hoof Repair	131
Hoof Packing	135
Hoof Pads	136
Kevin Bacon's	144
Hoof Treatments	147
Hoof Boots	151



## **Studs** **155**

Pro Grip Studs	156
Stud Accessories	157



## **Education** **159**

Books	160
DVDs	167
Hoof Plastinates	170
3D Hoof Models	171



## **Clothing** **172**

Farrier Chaps	173
Other Clothing	177
Jewellery	180



## **Horse Care** **183**

Kevin Bacon's	184
Other Horse Care	185





# HORSESHOES





## Shoe Size

Inches	mm
3	76
3 1/4	83
3 1/2	89
3 3/4	95
4	102
4 1/4	108
4 3/8	111
4 1/2	114
4 5/8	118
4 3/4	121
4 7/8	124
5	127
5 1/8	130
5 1/4	133
5 3/8	137
5 1/2	140
5 5/8	143
5 3/4	146
5 7/8	149
6	152
6 1/8	156
6 1/4	159
6 3/8	162
6 1/2	165
6 5/8	168
6 3/4	172
6 7/8	175
7	178
7 1/4	184
7 1/2	191
7 3/4	197
8	203
8 1/4	210
8 1/2	216
9	229

## Section

Inches	mm
5/8 x 1/4	16 x 6
5/8 x 5/16	16 x 8
5/8 x 3/8	16 x 10
5/8 x 7/16	16 x 11
3/4 x 1/4	19 x 6
3/4 x 5/16	19 x 8
3/4 x 3/8	19 x 10
3/4 x 7/16	19 x 11
7/8 x 5/16	22 x 8
7/8 x 3/8	22 x 10
7/8 x 7/16	22 x 11
7/8 x 1/2	22 x 13
1 x 1/4	25 x 6
1 x 5/16	25 x 8
1 x 3/8	25 x 10
1 x 7/16	25 x 11
1 x 1/2	25 x 13
1 1/4 x 3/8	31 x 10
1 1/4 x 1/2	31 x 13
1 1/2 x 1/2	38 x 13

### HOW TO MEASURE HOOF WIDTH FOR SHOE SIZING



Measure the width of the hoof at its widest point. Use the table above to convert your measurement into the appropriate shoe size.

# RIDING SHOES

## HMS UK Concave Shoes



HMS are manufactured in the UK.

- ⊙ Close in quality to a hand-forged shoe
- ⊙ Symmetrical, elliptical shape
- ⊙ Easy to fit upright heels
- ⊙ Precision nail holes
- ⊙ Unique bob-punched clips
- ⊙ Hinds are sided with safed inside heel and toe
- ⊙ Full range of sizes available - from small pony to heavy horses
- ⊙ Fronts available in sizes 1 to 14
- ⊙ Hinds available in sizes 1 to 13

### Size (front)

### Width (inches)

Size (front)	Width (inches)
1	4
2	4 ¼
3	4 ½
4	4 ¾
5	5
6	5 ¼
7	5 ⅝
8	5 ½
9	5 ¾
10	6
11	6 ⅙
12	6 ⅜
13	6 ½
14	6 ⅞

Section (inches)	Toe clipped fronts	Side clipped fronts	Quarter clipped hinds
¾ x ⅞	1-6	3-6	1-6
¾ x ⅝	4-7	4-7	4-7
⅞ x ⅝	8-10	8-10	8-10
⅞ x ⅞	11-12	11-12	11-12
1 x ⅞	13-14	13-14	13





## O'Dywer Performa



Toe clipped front

- U Available in toe clipped fronts and quarter clipped hinds

Size (front)	Width (inches)	Section (mm)
3	4 ¾	20 x 10
4	4 7/8	20 x 10
5	5 1/8	20 x 10
6	5 3/8	20 x 10
7	5 1/2	22 x 10
8	5 3/4	23 x 10
9	6	23 x 10

## Kerckhaert Classic Star



Toe clipped and side clipped fronts



Quarter clipped hind

- U A European style wide-web steel shoe
- U Ideal for warmbloods or those equines in need of extra support

Available in:

- U Toe clipped fronts sizes 3x0 - 4
- U Side clipped fronts sizes 0 - 3
- U Quarter clipped hinds sizes 3x0 - 4

Size (front)	Width (inches)	Section (mm)
3x0	4 ¾	18 x 9
2x0	5	20 x 10
0	5 ¼	20 x 10
1	5 ½	20 x 10
2	5 ¾	22 x 10
3	6	22 x 10
4	6 ¼	23 x 11

# RIDING SHOES

## Kerckhaert Century



Toe clipped front

- U Ideal choice for larger riding or driving horses
- U Inner bevel and solid heels
- U Available in toe clipped fronts and quarter clipped hinds

Size (front)	Width (inches)	Section (mm)
2x0	5	22 x 8
0	5 ¼	22 x 8
1	5 ½	22 x 8
2	5 ¾	24 x 9
3	6	24 x 9
4	6 ¼	25 x 10
5	6 ¾	25 x 11
6	7 ⅛	28 x 12
7	7 ¾	30 x 12

## Kerckhaert Classic Sport



Toe clipped front



Side clipped front



Quarter clipped hind

Similar design to the Kerckhaert Classic range, but with drilled and tapped 3/8" stud holes, making this shoe perfect for the modern sport-horse.

Available in:

- U Toe clipped fronts, sizes 2x0 - 3
- U Side clipped fronts, sizes 0 - 3
- U Quarter clipped hinds, sizes 2x0 - 3

Size (front)	Width (inches)	Section (inches)
2x0	5	¾ x ⅝
0	5 ¼	¾ x ⅝
1	5 ½	¾ x ⅝
2	5 ¾	7/8 x ⅝
3	6	7/8 x ⅝



## Kerckhaert Classic Rollers



Side clipped front



Side clipped front

- U Half round fullered section
- U European style steel side clipped front shoes to assist breakover

Available in:

- U Side clipped fronts, sizes 3x0 - 4
- U Quarter clipped hinds, sizes 0 - 3

Size (front)	Width (inches)	Section (mm)
3x0	4 ¾	20 x 8
2x0	4 ⅞	20 x 8
0	5 ⅛	22 x 8
1	5 ⅜	22 x 8
2	5 ½	22 x 8
3	5 ¾	24 x 8
4	6	24 x 8

## Mustad Equi-Librium Steel Shoes



Side clipped front

- U Steel flat shoe with assisted breakover at the toe area
- U Available in side clipped fronts

Size (front)	Width (inches)
0	5 ¼
1	5 ½
2	5 ¾
3	6
4	6 ¼

# RIDING SHOES

## Kahn Forge Leap Shoes



Side clipped front



Quarter clipped hind

- U A very well made horseshoe for riding and competition horses
- U Easy to fit shape
- U Plenty of nail hole choice and well formed clips to keep the shoe in place on the foot
- U Available in side clipped fronts and quarter clipped hinds

Size (front)	Width (inches)	Section (mm)
2x0	4 <sup>7</sup> / <sub>8</sub>	25 x 8
0	5 <sup>1</sup> / <sub>4</sub>	26 x 8
1	5 <sup>1</sup> / <sub>2</sub>	26 x 8
2	5 <sup>3</sup> / <sub>4</sub>	27 x 8
3	6	27 x 8

## Malaysian Quality



Toe clipped and side clipped fronts



Quarter clipped hind

- U Fully fullered concave mild steel horseshoe
- U For riding horses

Available in:

- U Toe clipped fronts, sizes 0 - 7
- U Quarter clipped hinds, sizes 0 - 7
- U Side clipped fronts, sizes 2- 6

Size (front)	Width (inches)	Section (mm)
0	4 <sup>1</sup> / <sub>2</sub>	18 x 8.5
1	4 <sup>3</sup> / <sub>4</sub>	19 x 9
2	5	19 x 9
3	5 <sup>1</sup> / <sub>4</sub>	20 x 9
4	5 <sup>1</sup> / <sub>2</sub>	21 x 9.5
5	5 <sup>3</sup> / <sub>4</sub>	22 x 10
6	6	23 x 10.5
7	6 <sup>1</sup> / <sub>4</sub>	23 x 10.5



## Malaysian General Purpose



Toe clipped front



Quarter clipped hind

- U Broad web suitable for hacks, hunters, eventers and other riding horses
- U Easy to drill for stud holes
- U Available in toe clipped fronts and quarter clipped hinds

Size (front)	Width (inches)	Section (mm)
8	6 ½	26 x 10

## Irish Quality



Side clipped front

- U Fullered lightweight concave section shoe with boxed off heels
- U Available in side clipped fronts, sizes 1 and 7 only

Size (front)	Width (inches)	Section (inches)
1	4 ¾	¾ x ¾
7	6 ¼	¾ x ¾

# RIDING SHOES

## St Croix Steel Eventer



Side clipped front



Quarter clipped hind

- U Drop forged from premium steel
- U Wear resistant
- U Solid heels makes them suitable for drilling or punching stud holes
- U Available in side clipped fronts and quarter clipped hinds

Size (front)	Width (inches)	Section (mm)
2x0	4 ¾	21 x 8
0	5	21 x 9
1	5 ¼	22 x 9
2	5 ½	22 x 9
3	5 ¾	23 x 10
4	6	23 x 10

## St Croix Steel Advantage



Quarter clipped hind and side clipped front

- U Drop forged from premium steel
- U Wear resistant
- U Solid heels makes them suitable for drilling or punching stud holes
- U Available in side clipped fronts and quarter clipped hinds

Size (front)	Width (inches)	Section (mm)
2x0	4 ¾	21 x 8
0	5	21 x 9
1	5 ¼	22 x 9
2	5 ½	22 x 9
3	5 ¾	23 x 10



## New Zealand Concave



Toe clipped front



Toe clip or quarter clipped hinds

- U Drop forged mild steel horse shoes
- U Concave section for better grip

Available in:

- U Toe clipped fronts, sizes 3x0 - 6
- U Toe clipped hinds, sizes 3x0 - 4
- U Quarter clipped hinds, sizes 3 - 6

Size (front)	Width (inches)	Section (mm)
3x0	4 1/2	16 x 7.5
2x0	4 5/8	16 x 7.5
0	4 3/4	17 x 7.5
1	5	18 x 8
2	5 1/4	19 x 8
3	5 1/2	20 x 8
4	5 5/8	20.5 x 8
5	5 7/8	21 x 9
6	6 1/8	21 x 9.5

## Concave Steel Horseshoes



Toe clipped front



Quarter clipped hind

- U English style concave steel horseshoes
- U Ideal for sport horses
- U Sold per box of 5 pairs (all the same size and style)
- U Available in toe clipped fronts and quarter clipped hinds

Size (front)	Width (inches)	Section (inches)
4	5	3/4 x 3/8
5	5 1/4	3/4 x 3/8
6	5 1/2	3/4 x 3/8
7	5 3/4	7/8 x 3/8
8	6	7/8 x 3/8
9	6 1/4	7/8 x 7/16

## Vulcan Concave



Side clipped front



Quarter clipped hind

- U Modern concave section horseshoe
- U Deep fullering and clear positive nail holes
- U Seated out for sole relief with extra wide toe for strength and cover

Size (front)	Width (inches)	Section (inches)
5	4 $\frac{3}{4}$	$\frac{3}{4} \times \frac{3}{8}$
6	5	$\frac{3}{4} \times \frac{3}{8}$
7	5 $\frac{1}{4}$	$\frac{3}{4} \times \frac{3}{8}$
8	5 $\frac{1}{2}$	$\frac{3}{4} \times \frac{3}{8}$
9	5 $\frac{3}{4}$	$\frac{7}{8} \times \frac{3}{8}$
10	6	$\frac{7}{8} \times \frac{7}{16}$
11	6 $\frac{1}{4}$	$\frac{7}{8} \times \frac{7}{16}$
12	6 $\frac{1}{2}$	1 x $\frac{7}{16}$
13	6 $\frac{3}{4}$	1 x $\frac{7}{16}$
14	6 $\frac{3}{4}$	1 x $\frac{1}{2}$



# PONY SHOES

## Kerckhaert Kings Pony Aluminium



Unclipped front



Unclipped hind

- Very small plates for very small feet
- Unclipped aluminium
- Steel insert in the toe for extra wear

### Size (front)

### Width (inches)

3x0	3 ½
2x0	3 ¾
0	4
1	4 ¼

## Kerckhaert Kings Steel Pony



Toe clipped front



Toe clipped hind

- Small lightweight steel pony shoes
- Available in toe clipped fronts and toe clipped hinds

### Size (front)

### Width (inches)

0	4
1	4 ¼

# PONY SHOES

## Malaysian Steel Pony



Toe clipped front



Quarter clipped hind

Steel pony shoes.

Available in:

- U Toe clipped fronts, sizes 2x0 - 0
- U Quarter clipped hinds, sizes 2x0 - 0
- U Universal toe clip - to be used for fronts and hinds, size 3x0

Size (front)	Width (inches)	Section (mm)
--------------	----------------	--------------

3x0	3 ½	15 x 8
-----	-----	--------

2x0	4	16 x 8
-----	---	--------

0	4 ½	16 x 8
---	-----	--------

# HEAVY HORSE SHOES

## Kerckhaert Workhorse



Toe clipped front



Toe clipped hind

- U Large shoes suitable for heavy horses and Clydesdales etc
- U A heavy section of shoe: 32 x 12mm (approx 1 1/4 x 1/2")
- U Toe clipped front and hinds

Size (front)	Width (inches)	Section (mm)
6	7	32 x 12
7	7 1/2	32 x 12
8	8	32 x 12



## Free NZ Shipping

when ordering from [farrier-shop.com](http://farrier-shop.com)

# RACING SHOES

## Malaysian Steel Trainers



Toe clipped front



Toe clipped and quarter clipped hinds

- Lightweight steel shoe suitable for racehorses and other horses requiring lighter shoes

Available in:

- Toe clipped fronts, sizes 2 - 8
- Toe clipped hinds, sizes 2 - 8
- Quarter clipped hinds, sizes 3 - 8

Size (front)	Width (inches)	Section (mm)
2	4 ¼	17 x 8
3	4 ⅞	17.5 x 8
4	4 ⅝	18 x 8
5	4 13/16	18 x 8
6	5	19 x 8
7	5 ¼	19 x 8.5
8	5 ½	20 x 8.5

## Kerckhaert Kings Steel



Toe clipped front



Toe clipped and quarter clipped hinds

- Light steel shoe ideal for thoroughbreds and finer walled horses
- Available in toe clipped fronts, toe clipped hinds and quarter clipped hinds

Size (front)	Width (inches)
3	4 ⅝
4	4 ⅞
5	5
6	5 ⅞
7	5 ¼



## Kings ES Steel Plus



Toe clipped and side clipped fronts



Quarter clipped hind

Provides a great option that's between a steel training plate and a traditional concave riding shoe.

Available in:

- U Toe clipped fronts, sizes 4, 5, 6, 7, and 8
- U Quarter clipped hinds, sizes 4, 5, 6, 7, 7.5 and 8
- U Side clipped fronts, sizes 5, 6, 7, and 7.5

### Size (front)

### Width (inches)

4	4 <sup>7</sup> / <sub>8</sub>
5	5
6	5 <sup>1</sup> / <sub>8</sub>
7	5 <sup>1</sup> / <sub>4</sub>
7.5	5 <sup>1</sup> / <sub>2</sub>
8	5 <sup>3</sup> / <sub>4</sub>

## Kerckhaert DR



Unclipped front

- U Light steel unclipped front shoes and toe clipped hinds
- U Ideal for shoeing yearlings and two-year-olds

### Size (front)

### Width (inches)

### Section (mm)

2	4 <sup>1</sup> / <sub>2</sub>	15 x 7
3	4 <sup>5</sup> / <sub>8</sub>	15 x 7
4	4 <sup>7</sup> / <sub>8</sub>	15 x 7
5	5	15 x 7
6	5 <sup>1</sup> / <sub>8</sub>	15 x 7
7	5 <sup>1</sup> / <sub>4</sub>	15 x 7

# RACING SHOES

## Kahn Forge Premier Shoes



Toe clipped front



Toe clipped and quarter clipped hinds

- Kahn Forge Premier light steel shoes
- An easy to fit shape, these shoes are suitable for lighter horses including thoroughbreds
- Available in toe clipped fronts, toe clipped hinds and quarter clipped hinds

### Size (front)

### Width (inches)

3x0

4  $\frac{3}{4}$

2x0

5

0

5  $\frac{1}{4}$

1

5  $\frac{1}{2}$



## Let us know

if you can't find what you're looking for. We may already have it in stock.

# ALUMINIUM SHOES

## Thoro'Bred Queens ED Plates



Toe clipped front



Toe clipped and quarter clipped hinds

- Made in California, USA, these aluminium racing plates are a great shape for thoroughbreds, have plenty of nail hole choices with good pitch and lightweight for the competitive advantage

Available in:

- Toe clipped fronts, sizes 4, 5, 6, 7, and 8
- Toe clipped hinds, sizes 4, 5, 6, 7, 7.5 and 8
- Quarter clipped hinds, sizes 5, 6, 7, and 8

### Size (front)

### Width (inches)

4	4 $\frac{3}{4}$
5	5
6	5 $\frac{1}{8}$
7	5 $\frac{1}{4}$
7.5	5 $\frac{1}{2}$
8	5 $\frac{3}{4}$

## Thoro'Bred Queens ED 2 Degree Wedge Plates



Toe clipped hinds

- Aluminium Thoro'Bred Queens ED 2 degree wedge racing plates
- Has a 2 degree wedge for raising the heel
- Available in toe clipped hinds

### Size (front)

### Width (inches)

5	4 $\frac{7}{8}$
6	5 $\frac{1}{8}$
7	5 $\frac{3}{8}$
8	5 $\frac{5}{8}$

# ALUMINIUM SHOES

## Thoro'Bred Queens ED Leg Saver Plates



Toe clipped front

- U Bonded Thoro'Bred Queens ED aluminium racing plates
- U Available in toe clipped fronts

Size (front)	Width (inches)
--------------	----------------

5	5
6	5 1/8
7	5 1/4
7.5	5 1/2
8	5 3/4

## Kerckhaert Kings Bonded Aluminium



Toe clipped front

- U Kerckhaert bonded aluminium Extra Sound fronts
- U Bonded with rubber for absorbing concussion
- U Toe clipped fronts

Size (front)	Width (inches)
--------------	----------------

4	4 7/8
5	5
6	5 1/8
7	5 1/4
8	5 3/4





## Kerckhaert Safety Trackx



Toe clipped front



Toe clipped hind

- Lightweight aluminium shoe with raised outer rim that provides extra traction
- Based on the Kings ES design with a symmetrical shape
- Available in toe clipped fronts and toe clipped hinds

### Size (front)

### Width (inches)

5

5

6

5 1/8

7

5 1/4

7.5

5 1/2

## Kerckhaert Kings ES Aluminium



Toe clipped front



Toe clipped and quarter clipped hinds

- Extra Sound shoes designed with a wider section than the standard Kings Plate
- Gives the foot more support
- Popular shoe for racehorses
- Available in toe clipped fronts, toe clipped hinds and quarter clipped hinds

### Size (front)

### Width (inches)

2

4 3/8

3

4 5/8

4

4 7/8

5

5

6

5 1/8

7

5 1/4

# ALUMINIUM SHOES

## Kerckhaert Super Sound



Toe clipped fronts



Toe clipped hinds

- Offers increased cover and support
- Super Pitch Plus has been introduced to the first three nail holes, giving extra pitch
- The toe design has been evolved to improve break over while the patented sole relief continues to protect against sole pressure and bruising

Available in:

- Toe clipped fronts, sizes 5, 6, 7, 7.5, 8 & 9
- Toe clipped hinds, sizes 5, 6, 7, 7.5 & 8

### Size (front)

### Width (inches)

5	5
6	5 1/8
7	5 1/4
7.5	5 1/2
8	5 3/4
9	6

## Kerckhaert Cu Super Sound



Toe clipped front



Toe clipped hind

- Kerckhaert copper plated super sound horseshoes
- A wider plate with the copper (Cu) plating to help to keep the hooves healthy
- Available in toe clipped fronts and toe clipped hinds

### Size (front)

### Width (inches)

5	5
6	5 1/8
7	5 1/4
7.5	5 1/2



## St Croix Concorde



Toe clipped and quarter clipped hinds

Lightweight aluminium racing plates with a steel insert at the toe for strength.

Available in:

- U Toe clipped fronts, sizes 2 - 9
- U Toe clipped hinds, sizes 2 - 8
- U Quarter clipped hinds, size 9

### Size (front)

### Width (inches)

2	4 <sup>7</sup> / <sub>16</sub>
3	4 <sup>5</sup> / <sub>8</sub>
4	4 <sup>7</sup> / <sub>8</sub>
5	5 <sup>1</sup> / <sub>8</sub>
6	5 <sup>1</sup> / <sub>4</sub>
7	5 <sup>7</sup> / <sub>16</sub>
8	5 <sup>11</sup> / <sub>16</sub>
9	5 <sup>7</sup> / <sub>8</sub>

## St Croix Eventer Aluminium



Side clipped front

- U A light weight horseshoe for sport horses
- U Steel toe insert for longer wear

Available in:

- U Side clipped fronts, sizes 2x0 - 4
- U Quarter clipped hinds, sizes 2x0 - 3

### Size (front)

### Width (inches)

### Section (mm)

2x0	4 <sup>3</sup> / <sub>4</sub>	21 x 8
0	5	21 x 9
1	5 <sup>1</sup> / <sub>4</sub>	22 x 9
2	5 <sup>1</sup> / <sub>2</sub>	22 x 9
3	5 <sup>3</sup> / <sub>8</sub>	22 x 10
4	6	22 x 10

# ALUMINIUM SHOES

## Kerckhaert Triumph Aluminium



Unclipped and side clipped fronts

- U Designed for modern sporthorses
- U Lightweight and provides support

Available in:

- U Unclipped fronts
- U Side clipped fronts
- U Wedged unclipped fronts

### Size (front)

### Width (inches)

3x0	4 <sup>3</sup> / <sub>4</sub>
2x0	4 <sup>7</sup> / <sub>8</sub>
0	5 <sup>1</sup> / <sub>8</sub>
1	5 <sup>1</sup> / <sub>4</sub>
2	5 <sup>1</sup> / <sub>2</sub>
3	5 <sup>7</sup> / <sub>8</sub>

## Kerckhaert Century Support Aluminium



Side clipped front

- U Designed to support heels and improve breakover
- U Gives farriers the benefits of both a concave and a 3/4 fullered shoe
- U Lightweight aluminium
- U Available in side clipped fronts and quarter clipped hinds

### Size (front)

### Width (inches)

2x0	4 <sup>3</sup> / <sub>4</sub>
0	5
1	5 <sup>1</sup> / <sub>4</sub>
2	5 <sup>1</sup> / <sub>2</sub>
3	5 <sup>5</sup> / <sub>8</sub>



## Mustad Equi-Librium



Side clipped front

The aluminium Equi-Librium shoe is good for:

- U Competition horses with extra knee action, horses judged on movement e.g. show hacks
- U Horses that need to make fast turns in their work
- U Horses in rehabilitation after a leg injury
- U Horses sensitive to strain or loading injuries
- U Horses requiring additional support provided by sole pads or silicone without increasing overall weight per foot
- U Available in side clipped fronts

### Size (front)

### Width (inches)

2x0	5
0	5 ¼
1	5 ½
2	5 ¾
3	6
4	6 ¼

## Kerckhaert Comfort Aluminium



Side clipped front

- U Designed for sporthorses
- U Wide web and plenty of support
- U Available in side clipped fronts

### Size (front)

### Width (inches)

0	5
1	5 ¼
2	5 ½
3	5 ¾

# ALUMINIUM SHOES

## Victory 3 Degree Wedge Hinds



Toe clipped hinds

- U 3° wedged heel designed for use on grass
- U Steel insert is same height as rim, increasing wear without adding traction

Size (hind)	Width (inches)
5	5
6	5 ¼
7	5 ⅜
8	5 ¾

## St Croix Concorde 3 Degree Hinds



Toe clipped hinds

- U St Croix Concorde 3 degree graduated aluminium hind shoes
- U Toe clipped hinds

Size (hind)	Width (inches)
4	4 ⅝
5	4 ⅞
6	5
7	5 ¼
8	5 ½



## St Croix Concorde 2 Degree Fronts



Toe clipped fronts

- St Croix Concorde 2 degree graduated aluminium shoes
- Toe clipped fronts

Size (hind)	Width (inches)
4	4 ¾
5	5
6	5 ¼
7	5 ⅝
8	5 ¾

Visit us in store at...



**115 West Coast Road  
Yaldhurst, Christchurch**

# HARNESS SHOES

## 3P Pacing Fronts



Unclipped front



- Lightweight unclipped front shoes
- Made from a section of steel which suits pacing horses and is easy for farriers to work with

Size (front)	Width (inches)	Section (mm)
--------------	----------------	--------------

0	4 $\frac{3}{8}$	12.5 x 6
1	4 $\frac{1}{2}$	12.5 x 6
2	4 $\frac{3}{4}$	12.5 x 6
3	4 $\frac{7}{8}$	12.5 x 6
4	5 $\frac{1}{8}$	12.5 x 6
5	5 $\frac{1}{4}$	12.5 x 6
6	5 $\frac{1}{2}$	12.5 x 6

## 3P Pacing Hinds



Toe clipped hind with wing



- Lightweight steel toe clipped hinds with a wing
- Wider outside branch
- The wing is easily removed for trainers or farriers who prefer a hind shoe which is wide outside, but has no wing

Size (front)	Width (inches)	Section (mm)
--------------	----------------	--------------

0	4	16 x 7
1	4 $\frac{3}{8}$	16 x 7
2	4 $\frac{1}{2}$	16.5 x 7.5
3	4 $\frac{3}{4}$	16.75 x 7.5
4	4 $\frac{7}{8}$	17 x 7.5
5	5 $\frac{1}{4}$	17 x 8
6	5 $\frac{1}{2}$	17 x 8





## O'Dwyer Steel Pacing Fronts



Unclipped front



- U Made from lightweight steel
- U Unclipped front shoes for harness horses

Size (front)	Width (inches)	Section (mm)
--------------	----------------	--------------

0	4 $\frac{3}{8}$	12.5 x 6
1	4 $\frac{1}{2}$	12.5 x 6
2	4 $\frac{3}{4}$	12.5 x 6
3	4 $\frac{7}{8}$	12.5 x 6

## O'Dwyer Steel Pacing Hinds



Toe clipped hind with wing



- U Steel toe clipped with a wing on the wider outside branch
- U Hind shoe for the harness horse

Size (hind)	Width (inches)	Section (mm)
-------------	----------------	--------------

0	4	16 x 7
1	4 $\frac{3}{8}$	16 x 7
2	4 $\frac{1}{2}$	16.5 x 7.5
3	4 $\frac{3}{4}$	16.75 x 7.5
4	4 $\frac{7}{8}$	17 x 7.5
5	5 $\frac{1}{4}$	17 x 8
6	5 $\frac{1}{2}$	17 x 8

# HARNESS SHOES

## O'Dwyer Steel Pacing No Wing Hinds



Toe clipped hind

- ⊖ Steel toe clipped hind shoe with wider outside branch
- ⊖ For the harness horse
- ⊖ No wing on outside branch

Size (hind)	Width (inches)	Section (mm)
2	4 ½	16.5 x 7.5
3	4 ¾	16.75 x 7.5
4	4 7/8	17 x 7.5
5	5 ⅛	17 x 8

## O'Dwyer Steel Sprinters



Toe clipped front

- ⊖ Lightweight steel racing shoe
- ⊖ Available in toe clipped fronts and toe clipped hinds

Available in sizes:

- ⊖ Fronts 3-6
- ⊖ Hinds 2-5

Size (front)	Width (inches)	Section (mm)
3	4 1 5/16	14 x 7
4	5 3/16	14 x 7
5	5 3/8	14 x 7
6	5 7/8	14 x 7



## Kerckhaert Trotting Half Round



Unclipped front

- U Half round, unclipped steel front shoes
- U Made by Kerckhaert, these are used by trainers of trotting horses
- U Available in light, medium and heavy weight sections

### Size (front)

### Width (inches)

2x0	4 ¾
0	5
1	5 ¼
2	5 ½

### Weight

### Section (mm)

Light	14 x 6
Medium	16 x 8
Heavy	18 x 9

## Werkman Trotting Short Shoes



Unclipped hinds

- U Steel trotting hind shoe
- U 14mm x 5mm light weight section
- U Steel unclipped hinds
- U Made by Werkman Horseshoes in the Netherlands

### Size (front)

### Width (inch)

### Section (mm)

00	4 ⅙	14 x 5
0	4 ½	14 x 5
1	4 ¾	14 x 5
2	5	14 x 5
3	5 ¼	14 x 5

# HARNESS SHOES

## Werkman Half Round Trotting Shoes



Unclipped front

- U A  $\frac{3}{4}$  fullered shoe with a half round stock profile
- U The half round profile provides easy break-over in all directions
- U Ideal for the front feet of trotting horses
- U Unclipped fronts
- U Available in light and medium weight sections

Size (front)	Width (inch)	Section (inch)
2x0	4 $\frac{1}{4}$	$\frac{1}{2}$ x $\frac{1}{4}$
0	4 $\frac{3}{8}$	$\frac{1}{2}$ x $\frac{1}{4}$
1	4 $\frac{5}{8}$	$\frac{1}{2}$ x $\frac{1}{4}$
2	5	$\frac{1}{2}$ x $\frac{1}{4}$
3	5 $\frac{3}{8}$	$\frac{1}{2}$ x $\frac{1}{4}$
2x0	4 $\frac{1}{4}$	$\frac{5}{8}$ x $\frac{5}{16}$
0	4 $\frac{1}{2}$	$\frac{5}{8}$ x $\frac{5}{16}$
1	4 $\frac{3}{4}$	$\frac{5}{8}$ x $\frac{5}{16}$
2	5 $\frac{1}{8}$	$\frac{5}{8}$ x $\frac{5}{16}$
3	5 $\frac{1}{2}$	$\frac{5}{8}$ x $\frac{5}{16}$

## Kerckhaert Legend Rim European



Toe clipped hind

- U Steel, toe clipped hind shoes
- U Suitable for trotting horses

Hind shoe size	Width (inches)
1	4 $\frac{1}{2}$
2	4 $\frac{3}{4}$
3	5 $\frac{1}{8}$
4	5 $\frac{1}{2}$



## Kerckhaert Half Swedge



Toe clipped hind

- U Half round, half swedge
- U Steel hind shoes
- U For harness racing horses

Available in:

- U Unclipped hinds, size 1
- U Toe clipped hinds, sizes 1.5 - 4

### Size (hind)

### Width (inches)

1	4
1.5	4 ¼
2	4 ⅜
2.5	4 ⅝
3	4 ⅞
3.5	5
4	5 ⅙

## Kerckhaert Full Swedge



Toe clipped hind

- U Steel
- U Popular shoe for harness racing
- U Available in unclipped fronts and toe clipped hinds

### Size (hind)

### Width (inches)

1	4
1.5	4 ¼
2	4 ⅜
2.5	4 ⅝
3	4 ⅞
3.5	5
4	5 ⅙

# HARNESS SHOES

## Half Moon Shoes



- U Half moon steel horseshoes for use with flapper pads

Size (front)	Width (inches)	Section (mm)
3	4 ¼	12.5 x 6
4	4 ¾	12.5 x 6
5	5	12.5 x 6
6	5 ¼	12.5 x 6

## Kerckhaert Kings Degree



Toe clipped hind

- U Graduated aluminium shoes
- U Toe clipped hinds available in sizes 4-8
- U Toe clipped fronts available in sizes 5-7

Also available in Kerckhaert Kings 3 Degree, in sizes 6 and 7 toe clipped hinds.

Size (hind)	Width (inches)
4	4 ⅝
5	4 ¾
6	5
7	5 ¼
7.5	5 ½
8	5 ¾



## Kerckhaert Fast Break



Side clipped and unclipped fronts

- U Aluminium shoe with a square toe
- U Flatter/shorter toe to improve breakover
- U Reduces pressure on flexor tendons/ligaments, as well as pressure to the back of hoof capsule

Available in:

- U Side clipped fronts, sizes 5-8
- U Unclipped fronts, sizes 4-7

### Size (front)

### Width (inches)

4	4 ½
5	4 ¾
6	5
7	5 ¼
8	5 ½

## Kerckhaert Outer Rim



Toe clipped and unclipped fronts

- U Aluminium outer rim fronts
- U Raised toe grab
- U Has a steel insert at the toe

Available in:

- U Toe clipped fronts, sizes 4 - 9
- U Unclipped fronts, sizes 4 - 9
- U Toe clipped hinds, sizes 5 - 8

### Size (front)

### Width (inches)

4	4 ½
5	4 ¾
6	5
7	5 ⅛
8	5 ¼
9	5 ½

# HARNESS SHOES

## Kerckhaert Tradition



Unclipped front

- U Dropped forged aluminium
- U Wider section and toe with coarser nail holes
- U Suitable for Standardbred harness horses
- U Unclipped fronts

Size (front)	Width (inches)
5	4 ¾
6	5
7	5 ⅙
8	5 ⅙

## St Croix Turf Plates



Unclipped front

- U Aluminium unclipped front racing plate
- U Narrower than regular Concorde plates
- U This shape often suits Standardbred harness racing horses
- U Unclipped fronts

Size (front)	Width (inches)	Section (mm)
4	4 ½	17 x 8
5	4 ¾	18 x 8
6	4 ⅞	19 x 8
7	5 ⅙	20 x 8
8	5 ⅙	21 x 8





## Thoro'Bred Pleasure



Unclipped front

- U Very popular steel shoe with a bevelled outer edge
- U Made in USA
- U Suitable for trotting horses
- U Available in unclipped fronts

### Size (front)

### Width (inches)

4	4 1/4
5	4 1/2
6	5
7	5 1/4
8	5 1/2
9	5 3/4
10	6

## Thoro'Bred World Racing Plates



Unclipped front

- U Aluminium shoe with squared-off toe
- U Provides ease of breakover to reduce strain on tendons and muscles
- U Available in unclipped fronts

### Size (front)

### Width (inches)

4	4 1/2
5	4 3/4
6	5
7	5 1/4
8	5 1/2

## Jim Blurton Remedial Shoes

Remedial shoes to help correct and alleviate foot problems in horses.

A unique feature of these shoes is the pitched nail holes, providing a different angle for each nail and making it easier to nail on.

These shoes incorporate a rolled toe and are safed off at the heel.

Side clips are standard and they have a countersunk position for stud holes.

Size (front)	Width (inches)
3x0	4 ½
2x0	4 ¾
0	5
1	5 ¼
2	5 ½
3	5 ¾
4	6
5	6 ¼



### Jim Blurton Graduated Bar

Three degree wedge bar shoes designed to assist in the realignment of the hoof pastern axis. This shoe has a set down bar which makes it easy to fit on a foot with a prominent frog.

This shoe offers a more stable platform for the horse than a wedge pad, increasing stability and reducing the flex in the foot.



### Jim Blurton Egg Bar

Oval shaped shoe and is usually used on horses with pre-navicular and navicular disease.

The shoe has a considerably enlarged heel-bearing surface and is usually applied to the front feet with a rolled toe. Recently, egg-bar shoes have been fitted to hind feet, as the extended heel surface gives support to horses with hock problems.



### Jim Blurton Heart Bar

---

Designed to offer maximum support to the foot and coffin bone whilst offering the farrier a shoe that is superbly balanced and easy to fit.

Heart-bar shoes can be used to help treat laminitis and flat feet.

The shoe mimics the unshod foot, as the frog and wall are restored to a natural pattern of weight bearing. The support offered to the coffin bone is crucial for speedy recovery and realignment.



### Jim Blurton Straight Bar

---

Offers support to the heel and frog, spreading the weight evenly throughout the foot.

The bar runs directly between the two heels, enlarging the ground-bearing surface at the back of the foot.

Ideal for competition horses, as the bar does not protrude excessively at the back of the foot.



### Jim Blurton Sport Hind

---

A bar shoe specifically designed for the hind foot. With plenty of nailing choices, quarter clips and counter-sunk stud hole placement, these bar shoes are ideal for horses – including those competing – who need the extra support on the hind feet.



Check out our latest deals on our website  
[www.farrier-shop.com](http://www.farrier-shop.com)

## VFT Steel Straight Bar Hinds



Three clipped hind

- U Made from special, highly wear-resistant steel alloy to enable both hot and cold shaping
- U The thickness and width is increased in proportion to the size of the shoe and all sizes are balanced around the centre of the shoe
- U Designed for easy and perfect nail fitting
- U 3 clips for versatility

### Size (front)

### Width (inches)

0	5
1	5 ¼
2	5 ½
3	5 ¾



## Follow us on Facebook

Follow [www.facebook.com/farriershop](http://www.facebook.com/farriershop) to hear our latest products and news.



## Vulcan Heart Bar Shoes



Side clipped front

- U Vulcan steel heart bar shoes
- U Features integrated sole relief and plenty of nail holes for a variety of nailing-on options
- U Side clips for stability
- U Sold by the pair

### Size (front)

### Width (inches)

6	5 ¼
7	5 ½
8	5 ¾
9	6

## Jim Blurton Aluminium Race Bar



Toe clipped front

- U Designed for thoroughbred racehorses, ideal for horses with weak heels
- U Drop-forged and heat treated
- U Provides sole relief
- U Rolled toe
- U Toe clipped fronts
- U Easy to work and long lasting

### Size (front)

### Width (inches)

3	4 ½
4	4 ¾
5	5
6	5 ¼
7	5 ½

# BARSHOES

## TTM Alloy Heart and Straight Bars



Unclipped heart bar front



Unclipped straight bar front

- U Machined from 8mm solid plate (aerospace grade)
- U Steel wear-resistant plate fitted behind the toe
- U Seated out on the solar side, machined at 10 degrees to prevent sole pressure
- U The 3 front holes are pitched to allow easier nailing
- U The toe has a machined bevel of 30 degrees to provide enhanced breakover
- U 6 nail holes in each branch for plenty of choice

Available in:

- U Unclipped heart bar fronts, widths 4 1/2" - 6 3/4"
- U Unclipped straight bar fronts, widths 4 1/2" - 6 1/4"

### Width (inches)

4 1/2
4 3/4
5
5 1/4
5 1/2
5 3/4
6
6 1/4
6 1/2
6 3/4

## Lightweight Steel Bar Shoes



Regular toe unclipped front



Squared-off toe unclipped front

- U Lightweight steel bar shoes – ideal for racehorses or when the farrier needs a bar shoe that isn't too heavy
- U Available with regular toe or squared-off toe

### Size (front)

### Width (inches)

3	4 1/4
4	4 3/4
5	5
6	5 1/4



## Jin Hung Aluminium Heart Bar



Unclipped front

- Lightweight, aluminium heart bar shoe
- Unclipped fronts

### Size (front)

### Width (inches)

3	4 ¾
4	5
5	5 ¼
6	5 ½

## Jin Hung Aluminium Straight Bar



Unclipped front

- Lightweight, aluminium straight bar shoe
- Unclipped fronts

### Size (front)

### Width (inches)

3	4 ¾
4	5
5	5 ¼
6	5 ½

## Kerckhaert Egg Bars



Side clipped front

- U Lightweight aluminium egg bar shoe
- U Side clipped front shoes

**Size (front)**                      **Width (inches)**

2x0	4 ¾
0	5
1	5 ¼
2	5 ½
3	5 ¾

## MV Rocking Support Wedge Eggbar



Three clipped front

- U Alloy egg bars with 2.5 degree wedge
- U 14 mm thickness at the rear bearing surface and 9 mm at the toe
- U 3 clips for use with one toe clip or two side clips; remove the clips you don't need

**Size (front)**                      **Width (inches)**

3x0	4 ¾
2x0	5
0	5 ¼
1	5 ½





## Z Bar Aluminium Shoe



Unclipped front

- U For use on heel cracks or heel problems
- U Steel toe insert for added wear
- U Sold by the pair – one left, one right

Size (mm)	Width (inches)
110	4 ¼
115	4 ½
120	4 ¾
125	5
130	5 ¼

## Z Bar Wide Aluminium Shoes



Unclipped front

- U Wider Z-bars suitable for thoroughbreds and horses with a rouser hoof shape
- U Good for horses with heel cracks or other heel problems
- U Sold by the pair – one left and one right

Size (front)	Width (mm)
26	112
28	118
30	124
32	130
34	136

## Aluminium Race Bar



Unclipped front

- Lightweight aluminium bar shoes, ideal for racehorses or other horses requiring a light bar shoe
- Unclipped front shoes

### Size (front)

### Width (inches)

26	4 $\frac{7}{16}$
28	4 $\frac{9}{16}$
30	4 $\frac{7}{8}$
32	5 $\frac{1}{8}$
34	5 $\frac{3}{8}$

## Spider Plate/Stabiliser Bar Shoe



Unclipped front

- High grade aluminium
- Provides protection and stabilisation
- Frog support functionality
- Sold by the pair

### Size (front)

### Width (mm)

2x0	124
0	130
1	136
2	142
3	148



## Mushroom Aluminium Shoe



Unclipped front

- U Aluminium mushroom bar shoe
- U Primarily used to transfer weight from the heel area to the frog
- U Ideal for some race-horses suffering from heel pain
- U Unclipped fronts only

Size (mm)	Width (inches)
110	4 ¼
115	4 ½
120	4 ¾
125	4 ⅞
130	5 ⅛

## Wedge Heart Bar Aluminium Shoe



Unclipped front

- U Aluminium graduated heart bar fronts
- U Unclipped fronts only
- U Wide toe
- U Breakover
- U Seated out

Size (fronts)	Width (inches)
2x0	4 ¾
0	5
1	5 ¼
2	5 ½
3	5 ¾
4	6
5	6 ¼
6	6 ½

## Open Toe Heart Bar Aluminium Shoe



- U Can be used in treatment of laminitis
- U Also known as the W shoe
- U Frog plate can be fitted to apply positive pressure
- U Sold by the pair

Size (front)	Width (mm)
3x0	118
2x0	124
0	130
1	136
2	142
3	148
4	154

# SPECIALIST SHOES

## EasyShoe Performance NG

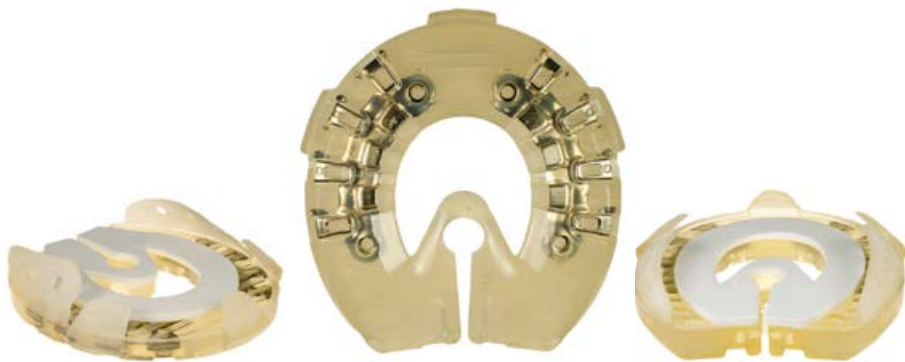

Three clipped front

Flexible urethane horse shoe, light and supportive for horses that need an alternative to metal shoes.

- U A glue-on horse shoe that can also be nailed
- U Two integrated nailing plates within the sole allow the shoe to accept up to 8 nails
- U Heels of the shoe can move independently to allow foot to expand and contract with each step
- U 3 toe clips keep the shoe in place without extending break-over
- U Translucent material allows the white line to remain visible during application
- U Optional spacer kit (right) allows you to open the back of the shoe to the desired width to aid the nailing on process



Optional spacer kit

### Size (front)

### Width (mm)

### Length (mm)

0	105 - 111	108 - 115
1	112 - 119	116 - 123
2	120 - 127	124 - 131
3	128 - 135	132 - 140
4	136 - 143	141 - 149
5	144 - 152	150 - 159

# SPECIALIST SHOES

## EasyShoe Compete



Unclipped front

Flexible and lightweight urethane shoe, ideal alternative to metal shoes.

- U Glue-on horse shoes
- U Thin-webbed shoe for use on the track or on turf
- U Internal metal spine allows for maximum adjustment to a wide variety of hoof shapes and sizes

Size (front)	Width (mm)	Length (mm)
0	95 - 115	111 - 118
1	105 - 125	119 - 127
2	115 - 135	128 - 136
3	125 - 145	137 - 143

## EasyShoe Sport



Unclipped front

A wide-webbed shoe that offers maximum support across the sole. The internal metal spine allows the shoe to be adjusted to many hoof shapes.

Size (front)	Width (mm)	Length (mm)
0	100 - 110	114 - 117
0.5	105 - 115	118 - 121
1	110 - 120	122 - 125
1.5	115 - 125	126 - 129
2	120 - 130	130 - 133
2.5	125 - 135	138 - 141
3	130 - 140	138 - 141



## Soundhorse Series 1 Elite



Unclipped front

Glue-on horseshoes which combine a forged aluminum shoe with a urethane shock-absorbing rim pad incorporating the strongest, safest attachment system. The fabric cuff gives a strong bond to the hoof using glue without nails. Shoes thickness of 16mm.

Available in:

- U Unclipped fronts, sizes 2x0, 0, 0.5, 1, 1.5, 2, & 3
- U Unclipped hinds, sizes 0, 1 & 2

Size (front)	Width (inches)	Web (mm)
2x0	4 1/4	19
0	4 1/2	21
0.5	4 3/4	22
1	5	22
1.5	5 1/4	24
2	5 1/2	24
3	5 3/4	25

## Soundhorse Series 1 XB



Unclipped front

Made for a Warmblood type, XB shoes have a blunt and rolled toe to assist in faster breakover which reduces stress on tendons and ligaments. These shoes are made with a standard built-in 1/4-inch thick blue polyurethane rim pad for unmatched shock reduction capability. Shoe thickness of 14mm.

Available in:

- U Unclipped fronts, sizes 2x0 - 3

Size (front)	Width (inches)	Web (mm)
2x0	5	22
0	5 1/8	22
1	5 1/4	22
2	5 1/2	22
3	5 7/8	22

# SPECIALIST SHOES

## Ibex BabiCuff Foal Extension Shoes



- For aiding the correction of deviations in foals
- These cuffs have an aluminium egg bar insert to give strength to the cuff and allow some limited shaping
- Each cuff has toe, heel, lateral and medial extensions. The farrier or vet cuts or rasps off the three extensions not required
- Use your choice of existing hoof glue to affix to the hoof - polyurethane, epoxy or acrylics

Size	Width (inches)
1	1 ½ - 2
2	2 - 2 ½
3	2 ½ - 3
4	3 - 3 ½

## Dalric Flaccidity Foal Shoe



For foals with weak flexors.

- Easy to apply
- Dramatic results
- Prevents crushed heels
- Prevents the usual heel bruises and abscesses
- Establishes proper joint alignment

Size	Width (inches)
D1	2
D2	2 ¾
D3	3 ¼





## Dalric Extension Foal Shoe



Designed to correct axial limb malformation in foals. The enlarged sole platform supports the foal's leg more than just on the propulsion surface of the hoof. The weight-bearing region of the sole is displaced, and the hoof adjusts to a new centre of gravity.

One-sided extension of the heel support encourages the foal to align the toe.

Should not remain glued onto the hoof for longer than 3 weeks.

### Size

### Width (mm)

Ext 1

55 - 70

Ext 2

70 - 80

Ext 3

90 - 100

## Nanric Foal Extension Shoe



Foal extensions made of lightweight and easy-to-use ABS plastic.

Used for correcting lower limb deformities in very young foals. Can be applied with Equimix Ultra Fast Hoof Bond & Repair or Equilox adhesives.

# SPECIALIST SHOES

## Dalric Club Foot Foal Shoe



For use in early stage of club foot syndrome. Most club feet develop 4-8 months of age. Early detection is vital for maximum results. Protects the coffin bone from trauma.

- U Easy to apply
- U Quick results
- U Reduces strain of deep flexor
- U Prevents bruising and abscesses
- U Reduces dish formation

Size	Width (inches)
------	----------------

B0	Up to 2
B1	Up to 2 ¾
B2	Up to 3 ¼

## Jim Blurton Lateral Extension Shoes



Quarter clipped hind

- U A wider outside branch for when the hind foot needs a little correction or support on the lateral side
- U Available in quarter clipped hinds, sizes 0 - 3
- U Sold by the pair - one left and one right shoe

Size (hind)	Width (inches)
-------------	----------------

0	5
1	5 ¼
2	5 ½
3	6



## Wide Toe Aluminium Shoe



Unclipped front

- U Multiple uses
- U Toe protection
- U Toe extension
- U Toe weight for racehorses
- U Wide toe prevents toe sinking into ground
- U Sold by the pair

Size (front)	Width (mm)
2x0	115
0	121
1	127
2	133
3	139



Visit us in store at..

**115 West Coast Rd  
Yaldhurst, CHCH 7676**

# SPECIALIST SHOES

## Denox Reverse Shoe



Unclipped front

The Reverse Shoe has a wide heel area coupled with narrow toe branches to give "float" to the heel area and allow sinking of the toe. It offers similar benefits to a wedge shoe without the disadvantages.

Aluminium unclipped front shoe.

Size (front)	Width (inches)
--------------	----------------

6	4 ¾
---	-----

7	5
---	---

8	5 ¼
---	-----

9	5 ½
---	-----

10	5 ¾
----	-----

## Denox Onion Shoe



Unclipped front

The Onion shoe protects the seat of corn from ground pressure.

Provides more "float" to the heel area by limiting heel penetration in soft ground. It offers good heel support with a roll over the toe and collateral aspects of the foot.

Aluminium unclipped front shoe.

Size (front)	Width (inches)
--------------	----------------

6	4 ¾
---	-----

7	5
---	---

8	5 ¼
---	-----

9	5 ½
---	-----

10	5 ¾
----	-----



## Natural Balance



Unclipped front



Quarter clipped hind

- Drop forged steel shoes
- Designed around principles of wild horses' hooves
- The square, rolled toe assists with better breakover
- Unclipped fronts and quarter clipped hinds

Size (front)	Width (inches)	Section (mm)
0	4 ½	20 x 9
1	4 ¾	22 x 9
2	5	22 x 9
3	5 ¼	23 x 9
4	5 ½	23 x 10
5	5 ¾	24 x 10.25
6	6	24 x 10.5

## Natural Balance Fitzy-Lites



Unclipped front

- Same design as Natural Balance shoes, but with a lighter section
- Unclipped fronts only

Size (front)	Width (inches)	Section (mm)
0	4 ½	17 x 8.5
1	4 ¾	18 x 8.5
2	5	18 x 8.75
3	5 ¼	19 x 8.75

# SPECIALIST SHOES

## Natural Balance Aluminium



Unclipped front

- U Same design as Natural Balance shoes but made from lightweight aluminium
- U Unclipped fronts

Size (front)	Width (inches)
0	4 <sup>3</sup> / <sub>4</sub>
1	5
2	5 <sup>1</sup> / <sub>4</sub>
3	5 <sup>1</sup> / <sub>2</sub>
4	5 <sup>3</sup> / <sub>4</sub>

## Kerckhaert Mountain Shoes with Heels



Side clipped hind

- U Mountain shoes - with "heels"
- U A classic shoe that has double heels for high country station work
- U Steel shoe
- U Available in hinds

Size (hind)	Width (inches)
2x0	4 <sup>3</sup> / <sub>4</sub>
0	5
1	5 <sup>1</sup> / <sub>4</sub>



## Razer Shoes



RW toe clipped front



SP toe clipped hind

Razer shoes are made of a special tempered tool steel that allows the shoe to flex to support the natural movements of the hoof.

The Razer concept was designed to mimic the natural function of the hoof while offering the protection needed for today's performance horses. This flexible tool steel was developed specifically for the Razer shoe concept.

The shoes were developed in Sweden in 2003 and have been the leading edge in the Standardbred racing industry. The technology was brought to the United States in 2005 to the American Standardbred racing industry.

In 2012, the shoe was redesigned. The toe was rounded and a rounded rim was added to enhance traction while reducing stress and the shape was redesigned to fit various horses, while still retaining all the flexibility of the original design.

Razer shoes come in a front (RW) and hind (SP) version. The hind is a popular choice for Standardbred horses. Razer's special tempered steel is almost as light as aluminium and much stronger than traditional steel shoes.

### Size (front)

### Width (inches)

RW 3x0

4 ¼

RW 2x0

4 ½

RW 0

4 ¾

RW 1

5

### Size (hind)

### Width (inches)

SP 3x0

4 ¼

SP 2x0

4 ⅝

SP 0

4 ¾

SP 1

5 ⅞

SP 2

5 ¼



## Ortho-Kit 2.0

- U Weld-in steel pieces for various hoof problems
- U Sold in pairs or as a full kit
- U Three sizes in each style



## Steel Heart Bar Inserts

- U Weld-in steel heart bar inserts
- U 7cm at widest point, 7cm long and 6mm thick



## Bar Stock

Concave UK shoemaking steel of approximately 1.63m lengths.

- U 5/8 x 5/16
- U 5/8 x 3/8
- U 3/4 x 3/8
- U 7/8 x 3/8
- U 7/8 x 7/16
- U 25mm x 11mm



## Weld on Heel Wedges

Weld-on heel wedges and calkins for extra grip during high country work.

Available in:

- U 10mm
- U 11mm
- U 13mm





### Tool Steel

---

Used for making farrier tools such as pritchels, forepunches, stud punches, chisels, etc.

Available in:

- U H13 tool steel 1" round (25mm)
- U S7 tool steel 3/4" round (19.5mm)



### Borium Bullets

---

Applied to horseshoes to provide extra grip.



### Borium Lengths

---

Can be applied to horseshoes to improve grip and give extra wear to the shoes.



# **NAILS**

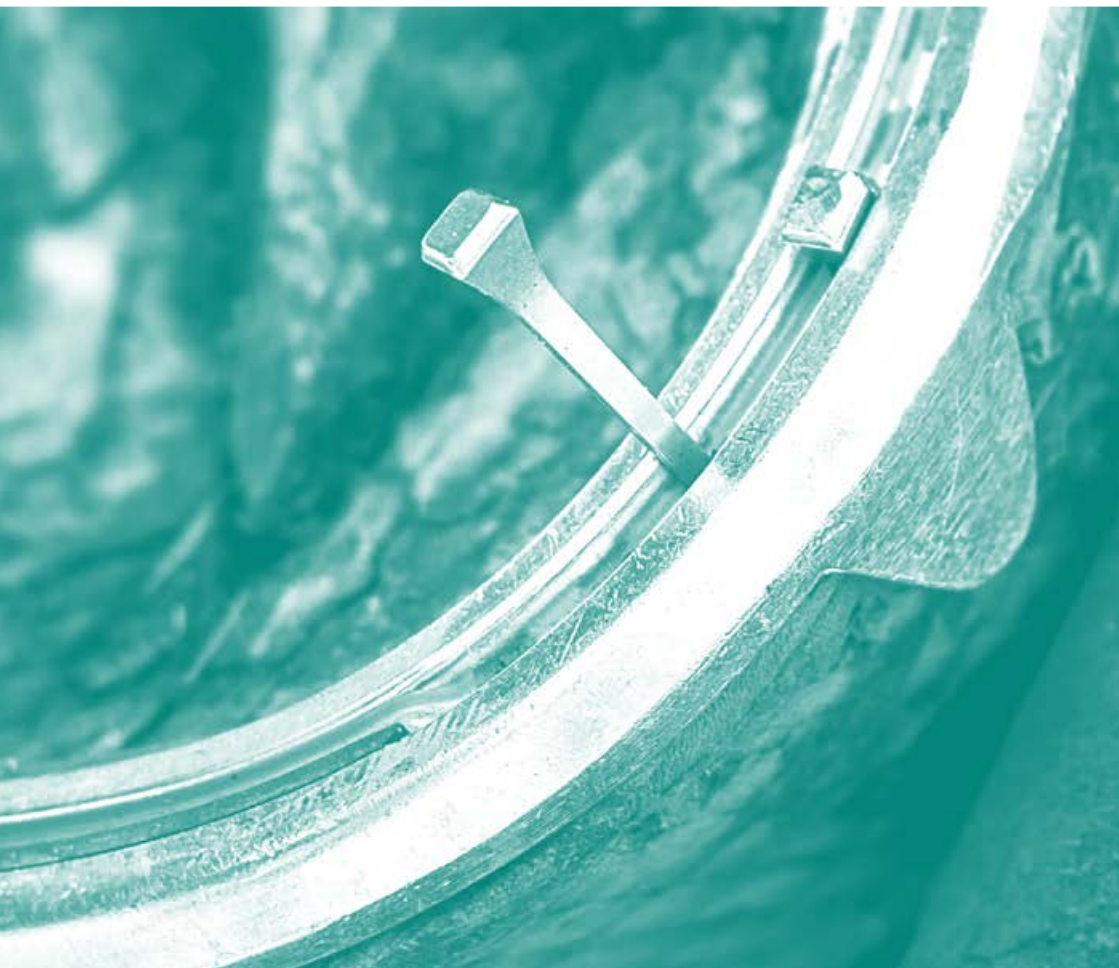



## Derby Nails



- These high quality Derby nails come in boxes of 250 pieces
- As used by professional farriers around the world

Size	Nails per box
E2 - E7	250
E2L	250
E3 slim - E5 slim	250
Race 4.5	250
CH5	250

## Liberty Nails



- Liberty horseshoe nails
- A high quality nail for the farrier who demands accurate and consistently reliable nailing

Size	Nails per box
E2 - E7	250
E8	100
E2 slim - E7 slim	250
BH3.5 - BH5	250
Race 5	250
Combo 5	250
Combo 5 slim	250

## Liberty Copper Nails



- Copper coated Liberty horseshoe nails
- For stronger, healthier hooves

Size	Nails per box
E3 slim - E7 slim	250

## Liberty Carrera Race Nails



- Creates a seamless fit in crease and nail holes regardless of race plate size
- Features a super slim shaft, causing less hoof wall damage
- Copper coated - no rust or wear inside the hoof, and antibacterial in nature

Size	Nails per box
Small	250
Medium	250
Large	250

Available in lengths:

- Small (equivalent to Race 3.5 or BH3)
- Medium (equivalent to Race 4.5 or BH3.5)
- Large (equivalent to Race 5 or BH4)



## Liberty Cu Hybrid Nails



- The Hybrid nail is a relatively new design of horseshoe nail manufactured to be suitable for different types of shoe
- Copper coated

Size	Nails per box
3	250
4	250
5	250
6	250

## Mustad Copper Nails



- Premium copper nails from Mustad
- One of the finest nails on the market for farriers

Size	Nails per box
E3 slim	250
E4 slim	250
E5 slim	250

## Mustad Nails



- U Made in Sweden
- U Mustad has set the standard for horseshoe nails

### Size

### Nails per box

E1 - E7	250
E10 - E12	100
E8 - E9	100
BH3.5, BH4 & BH5	250

## Mustad HammerHead Race Nails



- U A specially designed wider rectangular head to keep race plates and racing shoes in place securely for the duration of the shoeing period
- U Long thin shank to drive carefully through thinner walls of race horses
- U Pitch on the nails encourages accurate nailing

### Size

### Nails per box

Size 1 - Size 2	250
-----------------	-----



## Mustad Road Nails



- Steel road nails with tungsten insert in the end of the nails for added grip on roads, concrete etc

### Size

E3 - E5

### Nails per box

100

## March Nails



E Head



BH

- An great nail for the professional farrier at an affordable price

### Size

E2 - E12

BH3.5, BH4 & BH5

E2 slim - E7 slim

### Nails per box

250

250

250

## Brand-X Nails



- Brand-X horseshoe nails are made in the same factory as some other well known brands of horseshoe nail
- Same quality without paying for the brand name

Size	Nails per box
------	---------------

E2 - E6	250
E2 slim - E5 slim	250

## Australian Nails



- Australian horseshoe nails
- Available in boxes of 1000 or 1250 pieces
- Great value

Size	Nails per box
------	---------------

E3 - E5	1000
BH3.5, BH4, & BH5	1250



# FOOT TOOLS



## Hoof Nippers



### GE Hoof Nippers

- The premium hoof cutters for the professional
- Made in the USA, the GE brand sets the standard for hoof nippers and other farrier hand tools

Available in:

- Classic nippers - 14" and 15"
- Easy nippers - 12, 14" and 15"
- Easy Racetrack nippers - 14"



### Nordic Forge 14" Nippers

- Professional nippers featuring a wide 1" flat head and thin heat-treated jaw
- Cushion-grip handles
- Exceptional value



### Viking 14" Hoof Nippers

- A mid-priced reliable nipper for trimming hooves
- Very sharp blades which make hoof trimming a breeze
- Made in the USA



### Jim Blurton Nippers

- Made with stainless steel handles
- H13 heads for additional durability
- Perfectly balanced and comfortable in the hand

Available in lengths:

- 14"
- 15"



### Mustad 14" Nippers

- Precision machined and feature a hardened cutting edge to provide the best possible trim
- The edge stays sharper due to specially designed stops which prevent the blades from meeting just before cutting
- Rounded corners and strengthened jaw provide superior durability and a solid feel



### Kahn Forge 15" Hoof Nippers

- Polished, sharp and ready to work
- A great purchase for both quality and affordability
- Feature a smooth mechanism and cut efficiently and accurately



### Diamond 15" Nippers

- Cuts through horses hooves with ease. Provides great leverage and smooth cutting
- Diamond is a traditional brand for mid quality farrier tools
- Has a button rivet



## Carl Spring Loaded Hoof Nippers

- U Stainless steel spring loaded nippers to make the job easier
- U These are ideal for one handed use - when trimming foals or when you need to hold the leg in one hand and trim with the other
- U The internal spring is hidden away inside the jaws to keep it clean and protected
- U External screw locks the nippers when not in use
- U Available in 12" and 14"



## Half Round Hoof Nippers



### GE 12" Half Round Nippers

- U Designed originally for use in hoof wall work and clip placement
- U This tool is excellent for getting to those hard-to-get-at places on the hoof



### Jim Blurton 14" Half Round Nippers

- U For resections, cutting out clip holes and more
- U Stainless steel handles
- U H13 tool steel head - a premium nipper built to last

## Nail Cutters



### Kahn Forge 12" Nail Cutters

- U Polished finish, sharp and ready to cut
- U Features a sharp bite for cutting nails during clenching
- U Saves rasping and damage to your pull offs
- U Includes a magnet to easily collect and dispose of sharp nail ends safely



### GE EZ Nail Cutters

- U Features overlapping blades that shear the nail off close to the hoof, leaving a flat top to the nail which does not need to be rasped (rather than a peak)
- U No guess work - cuts the nail to the perfect length every time

## Knives

### Jim Blurton Hoof Knives



#### Jim Blurton Drop Blade Knife

Effortless cutting and very sharp.



#### Jim Blurton Straight Blade Knife

Available in left or right handed options.



#### Jim Blurton Loop Knife

Ideal for the horse's frog and particularly effective on hard feet during the dry summer months.



#### Jim Blurton Abscess Loop Knife

Perfect for farriers and vets for accurate precision work such as removing abscesses and hoof wall resections.



## Beanie Tools Hoof Knives

High grade hoof knives for farriers who expect quality. Unique ergonomic wooden handles for comfortable grip and easy cutting. The blades have been sharpened and coated with blue plastic for safer shipping. Made by multi-world champion farrier, Steven Beane, UK, these hoof knives are beautifully crafted and designed to help the farrier in their daily working life.



### Beanie Tools Hoof Knife

- U Brass tipper fitted on the end for burning on a hot shoe during shoeing
- U Curved blade
- U Right handed and left hand models
- U Blue-purple wooden handle



### Beanie Large Loop Flick Knife

- U Featuring a hooked blade for picking out the hooves before trimming
- U The Beanie signature flick groove on the end is a handy tool for grooving under the clenches when shoeing
- U Blue-purple wooden handle



### Beanie Wide Blade Knife Green

- U Wide blade knife with a brass tipper fitted at the reverse end for use when burning on
- U Green wooden handle



### Beanie Abscess Loop Knife

- U Double sided which makes digging out abscesses easier
- U Can be used by either left or right hand
- U Natural wooden handle

# FOOT TOOLS

## Baggett Hoof Knife

Extremely sharp, high quality, handmade knives with a raw finish. Right handed.

Blade styles available in:

- Offset blade
- Straight blade
- Large loop blade
- Detail loop blade

Blade widths available in:

- Narrow blade
- Wide blade

Handle ends available in:

- No burn cap
- Burn cap



Offset Blade

Straight Blade

Large Loop Blade

Detail Loop Blade



Narrow Blade

Wide Blade

No Burn Cap

Burn Cap





## Hall Hoof Knives



The Hall knife uses high carbon steel that is heat treated and tempered through a time consuming, exacting process. This is done to a level that provides the best edge retention and ease of sharpening. After treating and assembly, each blade is skillfully hand sharpened to provide a superior trim of the frog & sole of the foot.



### Hall Loop Knife



### Hall Abscess Knife

Available in large and small abscess loops.



### Hall Drop Blade Knife

Available in right and left handed.



## Maurer Forge Knives

- U Maurer Forge drop blade – a beautifully hand made hoof knife
- U Unique wooden handles crafted from a variety of American woods
- U Available in regular handle or thin handle option for those who like a tighter grip or have smaller hands
- U Available in right and left handed



## Friedr. Dick Ascot Hoof Knife

- U The knife of choice for many experienced barefoot trimmers around the world. Perfect for professionals and those starting out with barefoot
- U High-quality special carbon steel with ergonomic rosewood handle
- U Available right or left-handed



## Carl Hoof Knife

- U An affordable option for a very good every-day hoof knife
- U Curved blade
- U Available in right hand only



## Chris Gregory Hoof Knives

- U The blade is a low-stain, high carbon steel that is hard enough to hold an edge, yet malleable enough to be sharpened to a razor edge in minutes
- U The Rooster Tail hoof pick at the end of the handle is designed to clean out the foot and be an aid for hot fitting
- U Available in:
  - U Long or short handle
  - U Left or right handed



## Knife Sharpeners



### Friedr. Dick Ascot 100mm Toeing Knife

- U Made in Germany from top quality materials
- U Trim frogs (particularly dried out and hard frogs), sole and hoof wall using a hammer
- U Full length including plastic handle is 280mm, length of blade 100mm
- U Height at cutting blade 30mm



### Swiss Knife Sharpener

- U The knife sharpener preferred by many hoof-care professionals around the world because it really works!
- U Easy to use quality sharpener ideal for use on quality farrier knives and also scissors, household knives, fishing hooks and even tin openers
- U Made in Switzerland



### Paul Mitchell Knife Sharpener

- U Premium Diamond sharpener for a perfect cutting edge
- U Double ended, with its tapered conical end (6mm - 1mm diameter) fitting the smallest of loops to the largest
- U Always use with oil



### Save Edge Knife Sharpener

- U An industrial diamond grit sharpener for hoof knives
- U Features a broad blade and rounded corners to promote efficient sharpening
- U A popular choice for hoofcare professionals

## Rasps

### Save Edge Rasps



### Save Edge Original 14" Rasp

- U Very popular hoof rasp
- U The rasp of choice for professional farriers
- U Manufactured with one rough side to rasp the bulk of the horn away and one smoother side to give a clean finish and remove rasp marks
- U Tanged end for fitting a rasp handle (handle not included)
- U Made in the USA

### Save Edge 14" And 17" Beast Rasp

- U Extra wide compared to the regular Save Edge rasp
- U Fewer strokes when trimming the hoof
- U Easier to level the hoof
- U For farriers doing lots of trims, the Save Edge Beast Rasp is a labour saver



### Save Edge 14" Final Touch

- U The specially designed teeth on both sides produce a show quality finish on the hoof

### Save Edge Photo Finish rasp

- U The Save-Edge Photo Finish rasp combines the famous Save Edge 'rough' side with a smooth finishing rasp on the other



## Bassoli Rasps

14" Italian made Bassoli rasps, available individually or in boxes of six. Their tangs fit all of our rasp handles.



### Bassoli Farrier Rasp

- U Consistently sharp and durable
- U Has a rough cut side and a smoother side for finishing



### Bassoli Black Farrier Rasp

- U Exceptional cutting ability
- U Designed with the busy farrier in mind. The rough side rivals competitor products to remove hoof wall with minimal effort while the smooth side gives a nice finish
- U Black coated to extend the life of the rasp and give a clog-free cut



### Bassoli Blade Rasp

- U Has established a reputation amongst farriers worldwide and is the rasp of choice for many
- U Cuts through hoof with ease
- U Black coating helps reduce the teeth clogging up
- U One rough side and one smooth side



### Bassoli Finishing Rasp

- U Designed for producing a perfectly smooth finish to the hoof wall, free from rasp marks
- U Both sides are engineered for the final finish as opposed to having one side dedicated to removing larger volumes of the hoof
- U Produces a show finish for show ponies or for presenting yearlings and young stock for the sales



## Bassoli Costanza Rasp

- U 50mm wide for an easier flat finish on the hoof
- U The finishing side is slightly coarser than that on the Bassoli Blade



## Bassoli Fifty Rasp

- U 50mm wide - 6mm wider than regular rasps
- U Features a standard coarse side and a super sharp file side that leaves a smooth finish



## Bassoli Baby Rasp

- U Shorter in length than regular hoof rasps
- U Ideal for trimming minis, smaller ponies etc



## Cody James Dymondback Rasp

An efficient, long lasting tool as an alternative to your rasp. It will not clog and gets approximately three times the number of horses done compared to a regular rasp. Replace the blade when needed, not the frame. Easy on the wrists, elbows and shoulders. Includes one frame and one blade. Available with medium and aggressive blades.



# FOOT TOOLS

## Heller Rasps



### Heller Red Tang 14" Rasp

- ⊖ Especially well suited for rasping dry, hard hooves
- ⊖ Sharp file side allowing for easy removal of material with little effort



### Heller Legend 14" Rasp

- ⊖ White tang rasp used by farriers
- ⊖ Has one rough side for removal of hoof wall and a smoother side for tidying up and removing rasp marks
- ⊖ Tanged for fitting rasp handle (handle not included)



### Heller eXcel Rasp

- ⊖ Wider profile yet balanced and light
- ⊖ Improved leveling, efficiency and control due to a larger working surface
- ⊖ Extended coarse teeth to the edges for rasping in clips
- ⊖ Effective results in different conditions



### Heller eXcel Legend 14" Green Tang Rasp

- ⊖ It's green, it's mean, it's a hoof rasping machine!
- ⊖ Sold individually or in boxes of 5 rasps





## Other Rasps



### Heller GR8AT White Tang 14" Rasp

- U 8 rows of teeth on the coarse side
- U An easier rasping experience whilst still offering a similar sharpness and cutting result to other Heller rasps
- U Each rasp has a cardboard sleeve to protect the teeth whilst the rasp is being stored or shipped
- U The tanged end fits any of our regular hoof rasp handles - either screw on or drive on
- U Sold individually or in a box of 5

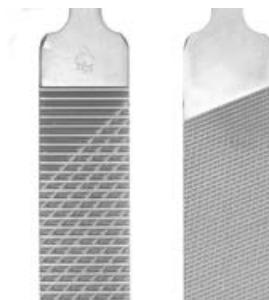

### Pferde 14" Hoof Plane

- U Pferde hoof plane - 14"
- U This isn't your normal hoof rasp
- U The innovative manufacturing process involves milling and hardening to make the hoof plane exceptionally long lasting compared to regular hoof rasps

## Rasp Covers



### Leather Rasp Cover

- U Protective leather cover for 14" rasps
- U Keep your rasp clean and dry when it's not in use

## Sanding Rasps

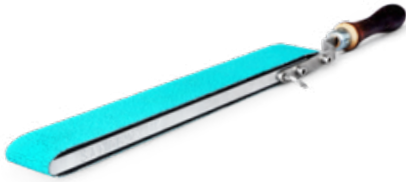

### Beanie Tools Sanding Box

- U Beanie Tools Sanding Box unit for polishing metal shoes or horses' hooves
- U A quick-release system ideal for the farrier competitor
- U Aluminium body, stainless steel brackets, wooden handle and a quick-release pin for when changing the sanding belt



### Beanie Tools Sanding Box Replacement Belts

- U Replacement belts for the Beanie Tools Sanding Box
- U 10" long

Available in:

- U 36 grit - 4 pack
- U 80 grit - 4 pack
- U Dual belt 36/80 grit - 2 pack
- U Dual belt 120/240 grit - 2 pack



### Viking Sanding Rasp

- U For an immaculate finish on the hoof wall
- U Remove rasp marks, blemishes and imperfections from the hoof wall when clenching, trimming or in competition environments
- U The sanding rasp comes with 3 velcro sanding removable belts. Replacement belts of various grits are also available



### Vft Sanding Belts

Fits the Viking sanding rasp. Sold in packs of 10.

Available in:

- U 60 grit (roughest)
- U 120 grit (finer)
- U 240 grit (finest)



## Rasp Handles



### Save Edge Screw On Rasp Handle

- U Screw-on rasp handle for Save Edge rasps
- U Will fit most other brands of rasp



### Wooden Screw-On Rasp Handle

- U Smooth wooden rasp handle designed to fit snugly into the hand
- U Fits most rasps, just screw on to add stability and comfort as you work



### Equithotics Rasp Handle

- U Equithotics drive-on rasp handle, available in a variety of colours
- U Ergonomically designed for comfort and grip
- U Fits all the rasps we sell



### Shoop Forge Rasp Handles

- U Bespoke rasp handles made in USA by Shoop Forge
- U Supplied with allen key to tighten the screw onto the rasp tang
- U Available in resin or wood in a range of colours

## Hoof Buffers



### Hoof Buffer Attachment

Drill attachment. Makes the sanding of the hoof wall quick and easy to leave a smooth finish.

Comes complete with sanding attachment, bladder and 1 x 100 grit belt.



### Bladders for Hoof Buffer Attachment

Replacement bladder fits inside hoof buffer attachment.



### Replacement Belts for Hoof Buffer Attachment

Available in:

- U 60 grit, 80 grit and 100 grit

## Clench Cutters and Buffers



### Nordic Forge Clench Cutter/Buffer

An economical clench cutter for cutting or lifting the clenches away from the hoof during the shoe removal process.



## Wire Brushes



### Jim Blurton Elite Buffer

---

- For lifting clenches during the shoe removal process
- Colourful wooden handle



### Nz Made Wire Brush

---

- New Zealand made wire brush with stainless steel bristles
- Ideal for in the tool box to clean off the feet/soles



### Flat Soft Wire Brush

---

Ideal for using on the horse's hoof.



### NZ Made Wire Brush with Arch Handle

---

Great for use on feet or hot shoes.



## Heavy Duty Wire Brush

For use when shoemaking in the forge.

## Pull-Offs



## GE Pull-Offs

- Top quality farrier pull-offs
- For pulling off shoes during the shoeing process
- Made in the USA by GE Forge & Tool
- Available in 14" Classic, 12" Easy, and 14" Easy



## Diamond 12" Pull-Offs

Has an exclusive pattern with sharp teeth on outside edges for ease in spreading most shoe sizes and styles.



## Nordic Forge Pull-Offs

Made in USA and represents exceptional value for money.



## Nail Pullers



### Mustad 14" Pull-Offs

Made of good quality steel for durability and sharpness for safe, efficient removal of shoes.



### GE Crease Nail Pullers

Made in the USA, these nail pullers from GE are a premium product for the professional farrier.



### Mustad Crease Nail Pullers

- Mid-quality nail pullers that give a good grip
- Used to pull nails out of shoe before removing shoe
- Blackened steel finish



### Kahn Forge Crease Nail Pullers

- 12 inches in length
- A mid priced polished farrier tool
- Fits snugly inside the crease/groove of the horseshoe so you can grab two sides of a horseshoe nail. With a little gentle leverage the nail can be loosened in the shoe and then pulled out. This method allows a single nail to be removed from the shoe without necessarily removing the shoe away from the hoof

## Nailing-On Hammers



### Flatland Forge Nailing-On Hammer

Quality nailing-on hammer with wooden handle from Jim and Kathleen Poor, USA.

- U Available in 8 oz, 10 oz, 12 oz and 14 oz weights



### Cavalry Nailing-On Hammer

With an octagon shaped face, the NC Tool Cavalry hammer is perfectly balanced. Slim handle for smooth strokes with little or no vibration.

- U Made with the finest tool steel in the USA
- U Available in 12oz weight



### Jim Blurton Nailing-On Hammer

Jim Blurton nailing-on hammer with wooden handle.

- U Precision nailing for the professional farrier
- U Available in 12oz and 14oz



### Diamond Nailing-On Hammer

A great affordable hammer for every day use when nailing on.

- U Available in 10oz weight





## Hammer Handles



### Nordic 10oz Nailing-On Hammer

Exceptional value for a standard quality farrier hammer. Made in the USA.



### Cavalry Nailing-On Hammer Handle

Replacement handle for the Cavalry 12 oz. farrier nailing on hammer.



## Hammer handle broken?

We can supply replacement hammer handles for most brands.

## Clenchers



### Kahn Forge Curved Jaw Clenchers

- U 13.5 inches in length
- U Folds the nail tip down into the hoof wall during the shoeing process
- U A mid-priced tool for clenching



### Diamond 12" Saddle Horse Clenchers

- U A simple style of clencher
- U Economical tool for occasional use



### Diamond 12" Farrier Clenchers

- U An aggressive style of clencher
- U Serrated ball pulls nails down and into the hoof
- U Flat bottom jaw



### Diamond 12" Gooseneck Clenchers

- U The Diamond Gooseneck clencher turns down and clenches heads of smaller nails while shoeing
- U Made from durable high quality steel
- U Fastened together with a button rivet



### Ge Curved Jaw Clenchers

---

- Used for clencher the nail into the hoof wall
- GE tools set the standard for farrier hand tools worldwide - made in the USA



### Ge Low Nail Clenchers

---

Low nail curved jaw - with shorter reins particularly suitable for racehorses and/or low nails.



### Mustad Standard Clenchers

---

A well-balanced clencher with a comfort grip appropriate for a variety of nailing heights

## Clenching Blocks/Groovers



### Vft Clenching Block

---

- U The Viking Farrier clenching block is designed to fit the hand comfortably
- U Lightweight and does not conduct cold in the hand on chilly days
- U The hardened steel insert is replaceable



### NC Clench Block

---

- U Used for clenching and seating nails
- U Made of solid steel

Measurements:

- U Height - 2"
- U Depth - 1 1/2"
- U Length - 4 3/4"



### Mustad Double-Ended Clench Groover

---

- U Removes a small amount of hoof under the nail for the clench to sit snugly in the hoof rather than on top
- U Double ended so it can be used left or right handed



## Other Hoof Tools



### Hoof Testers

- U Stainless steel hoof testers as used by vets, farriers and other professionals
- U Used to identify and locate abscesses, infections and stone bruises or pinpoint soreness in the hoof



### F. Dick Hoof Pick

- U Ergonomically designed hoof pick
- U Made in Germany from the finest materials
- U Strong and durable with rubber handle for comfort



### Jim Blurton Hot Fitting Tongs

- U Tapered ends shaped like a nail head to ensure a tight hold on the shoe
- U Designed to carry the hot shoe to the foot
- U Allows you to apply an even pressure to the shoe when fitting



## Combo Tool

---

- U A three-in-one tool
- U Ideal for those emergencies when you need to quickly take off a loose shoe or nail one back on
- U Easily pull apart the combo tool to give you a nailing hammer and clench cutter then snap the tool back together for pull-offs



## Tool Boxes



### Thoro'Bred Large Tool Box

- U Aluminium design
- U Bottom tray that lifts up for safe storage
- U Lots of space for lots of tools



### Thoro'Bred Small Tool Box

- U Aluminium farrier tool box
- U An affordable option for keeping your tools all in one place
- U Light and portable, it can be easily carried from horse to horse



### Thoro'Bred Model 90 Tool Box

- U Aluminium tool box
- U Wheels for portability
- U Two knife pockets and various storage places for all your farrier and trimming tools
- U Made in the USA



### Thoro'Bred Platers Special Tool Box

- U Two knife pockets at the back
- U Top trays for nails or other small tools
- U Two rasp dividers at each side of the box
- U Aluminium material





### Yoder Shorty Tool Box

---

- U Versatile and functional for carrying farrier tools around the horse or between jobs
- U Great design
- U Light weight



Did you know...

**You can order anything from your smartphone on our mobile website.**

It's quick, simple and easy to use.

**[www.farrier-shop.com](http://www.farrier-shop.com)**

## Hoof Stands

### Hoofjack

Hoofjack is designed to support the horse's foot through all phases of shoeing, trimming, treatment and daily care. Hoofjack provides a stable support for the horse to rest its foot on, allowing the horse to feel comfortable, secure and relaxed.

The Hoofjack base has two magnets for holding tools and nails and comes with one standard cradle, and one straight post with standard rubber cap. Free 40 minute Hoofjack instructional video included.

Trim and rasp without putting the hoof between your knees or supporting the horse with your body. Take your mind off your back and knees and put it back into your work.

Available in green, pink, red or purple.



#### Standard Hoofjack

- U Accommodates a pony up to a small draft or draft cross
- U The standard base is 12" in height and has a base diameter of 18"
- U Overall height adjustment is 14" - 22"



#### Medium Hoofjack

- U Has the same base diameter as the Standard Hoofjack but is 3" shorter
- U The medium Hoofjack can be used in place of the standard Hoofjack or it is ideal for small ponies, horses with limited range of motion or for users under 5'10" wanting to use Hoofjack for the front feet
- U The medium base is 9" in height and has a base diameter of 18"
- U Overall height adjustment is 11" - 19"



### Mini Hoofjack

- U Shorter and narrower than the standard Hoofjack. The mini base is 7" in height with a base diameter of 13"
- U Overall height adjustment is 8" - 12"



### Geriatric Hoofjack

- U Intended for horses with severely limited range of motion that would normally require you to work off the toe of your boot
- U Utilises a mini base which is 7" in height with a base diameter of 13"
- U Overall height adjustment is 8" - 13"



### Draft Hoofjack

- U For use on larger hooves
- U Includes a larger hoof cradle
- U The standard base is made of linear polyethylene which is 12" in height and has a base diameter of 18"
- U Overall height adjustment is 14" - 22"



### Combo Hoofjack

- U Consists of one standard base, one standard cradle, one standard straight post, one draft cradle and one draft straight post, making it ideal for people with small ponies through to large draft horses

**Check out our huge range**  
of farrier products – online, in store, or by phone.

## Measuring



### Jim Blurton Brass Rule

- U Polished brass rule
- U A fold out rule with both inches and mm
- U 24" and 610mm long



### Jim Blurton T-Square

- U Polished stainless steel t-square
- U A handy tool for assessing the balance of the foot in relation to the long axis (limb)



### Kowhai Forge Golden Mean Dividers

- U Measure ratios of the hoof
- U Polished stainless steel
- U Slide out native hardwood case



### Proportional Hoof Balance Tool

- U Measure the Golden ratio of 1:1.618
- U Stainless steel
- U Information sheet included



# **FORGING TOOLS**



## Forging Hammers



### Jim Blurton ARS Sledge Hammer

Designed by Andy Reader-Smith and made by Jim Blurton, this sledge hammer has a weighted head featuring the silver fern logo as a nod to the home country of the designer.



### Jim Blurton Turning Hammer

Jim Blurton shoe turning hammer for the professional farrier.

Available in:

- 2 lb
- 2.5 lb



### Derek Gardner Shoe Turning Hammer

Twice winner of the UK nationals, Derek Gardner is one of the world's top farriers. His stylish and practical range of tools are finished and inspected by Derek himself and highly sought after by farriers on both sides of the globe.

This well balanced shoe turning hammer is available in 1 3/4 lb, 2lb and 2 1/2 lb.



### Beanie Forging Hammer

- Beanie forging hammer from multiple world champion blacksmith Steven Beane, UK
- A forging hammer ideal for every day shoeing and also forging horseshoes
- Available in 1 3/4lb, 2lb and 2 1/4lb



## Fullers



### Mustad Fuller

---

- Hardened for durability to minimize the risk of splitting
- Available in E-head and City head



### Derek Gardner Hunter Fuller

---

Derek Gardner hunter fuller with wooden handle.



### Derek Gardner Guide Fuller

---

- Wooden handle
- Can be used with the hunter fuller

## Stamps



### Jim Blurton E Head Stamp

---

- U Jim Blurton E-head stamp with handle
- U For punching nail holes during shoe-making for the reception of E head horseshoe nails



### Jim Blurton City Head Stamp

---

- U Blurton City Head (CH) stamp for punching nail holes during the horseshoe-making process
- U Replaceable wooden handle

## Pritchels



### Jim Blurton E-Head Pritchel

---

Made from quality tool steel for the professional farrier.



### Jim Blurton Back Pritchel

---

Back pritchel for clearing the nail holes.





## Stud Punches



### Jim Blurton Carry Pritchel

---

For carrying shoe to the foot whilst hot fitting.



### Jim Blurton 3/8" Stud Punch

---

Jim Blurton 3/8" stud punch for the professional farrier.



### Derek Gardner 3/8" Stud Punch

---

The Derek Gardner handheld stud punch feels very comfortable in your hand and is set up perfectly for punching 3/8" stud holes.



### Derek Gardner 3/8" Stud Punch with Wooden Handle

---

3/8" stud punch with comfortable wooden handle.

## Taps



### Tap Wrench

Tap wrench handle for holding the engineers tap while cutting the threads in stud holes.



### 3/8" Engineer Tap

- U 3/8" middle tap
- U For cutting stud hole threads in shoes
- U 3/8" is the NZ standard for stud holes



### Bassoli 3 in 1 Stud Hole Drill Bit

- U Efficiently drills, taps and countersinks for stud holes
- U Holes (6mm) should be pre-drilled
- U Reverse drilling to avoid breaking the bit is recommended
- U 3/8" stud hole



## Fire Tongs



### Jim Blurton Snakehead Tongs

Quality forging tongs with a unique snakehead design.

Available in:

- U 6mm (1/4")
- U 8mm (5/16")
- U 10mm (3/8")
- U 11mm (7/16")
- U 12mm (1/2")



### NC Tool Co Tongs

Available in:

- U 1/4"
- U 5/16"
- U 3/8"
- U 1/2"



### Quick and Dirty V Bolt Tongs

- U A useful pair of tongs for any blacksmith or farrier
- U Made from 1045 steel
- U 18" length from one end to the other
- U Available to hold various sizes of steel

## Other Forge Tools



### Derek Gardner Forepunch

---

Derek Gardner E-head hunter forepunch (stamp) with wooden handle.



### Derek Gardner Bob Punch

---

- U A hand-held tool for starting the bubble when pulling a clip on horseshoes during shoe-making
- U Made from S1 tool steel



### Jim Blurton Clipping Punch

---

For clipping up shoes - also known as a bob punch. For the professional farrier who demands quality tools.



### VFT Tool Maintenance Compound

---

A tool maintenance compound designed to maintain and maximize your tools' performance.



## Flux



### Iron Mountain Forge Welding Flux

---

Iron Mountain welding flux - the preferred choice of blacksmiths and farriers.



### Sureweld Welding Flux

---

To assist with fire-welding in the forge.

## Anvils



### Yoder Stall Jack

---

- U Portable and ideal for the mobile farrier
- U Available in small (50cm high) and medium (55cm high)



### O'Dwyer 40kg Anvil

---

- U Suitable for the back of the truck
- U Turning cams and beak suitable for shaping a range of horseshoes
- U Other weights available on request



## JHM 70lb Anvil

Made of ductile iron, machined and heat treated in the USA.

This 70lb (31.75kg) anvil is one of the highest quality anvils you can buy. It is a good weight for the back of the truck for a mobile farrier, but also suitable for the workshop. The anvil has a 3" tapered heel and turning cams for bending steel.

Dimensions below:

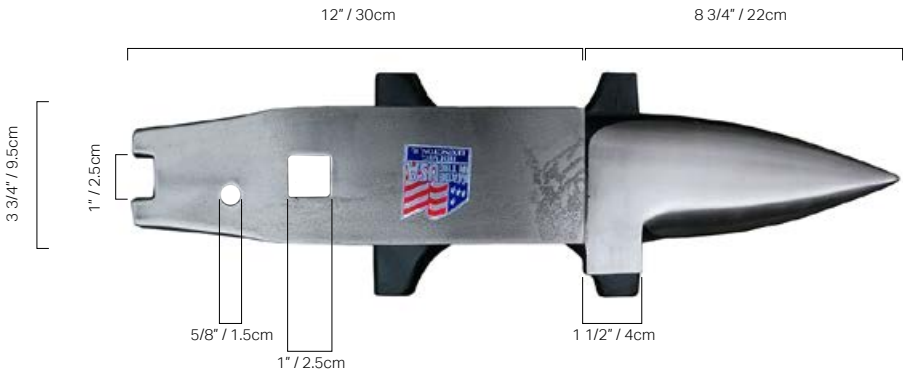



## NC Tool Co Big Face Anvil

- U 3 3/4" wide face great for leveling shoes
- U Turning cams
- U Opposing square & round cliphorns for making great clips and square toes. Also convenient for left handed shoers
- U Thin heel design
- U 1-1/4" chamfered, round turning hole in heel
- U 1" hardie hole in horn
- U Pritchel hole in heel

<b>Weight</b>	70lbs/31.8kg
<b>Face</b>	3 3/4" x 6"
<b>Heel</b>	3 1/4" x 5"
<b>Horn</b>	3 1/2" x 8"
<b>Height</b>	8 3/4"
<b>Base</b>	11" x 9"

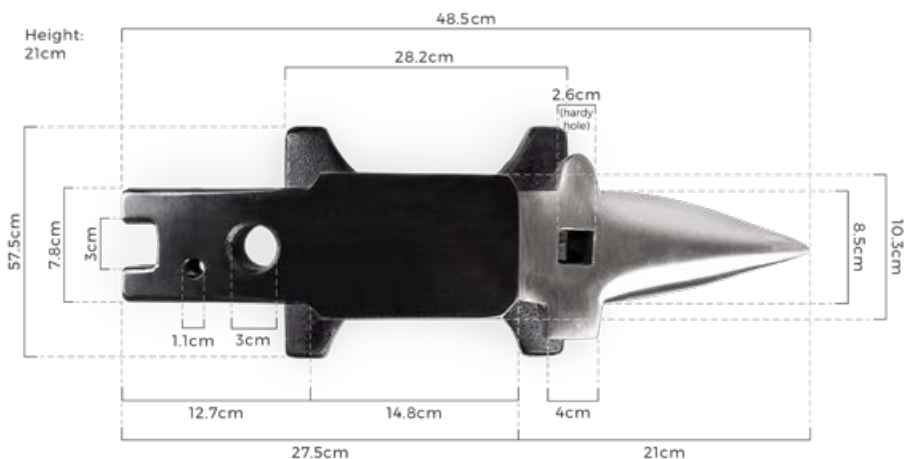



## Centurion Anvil

- U 38kg farrier anvil
- U Turning cams on the hanging anvil
- U Wide face
- U Clipping table for pulling clips
- U Made of high tensile steel
- U Suitable for the forge or the truck

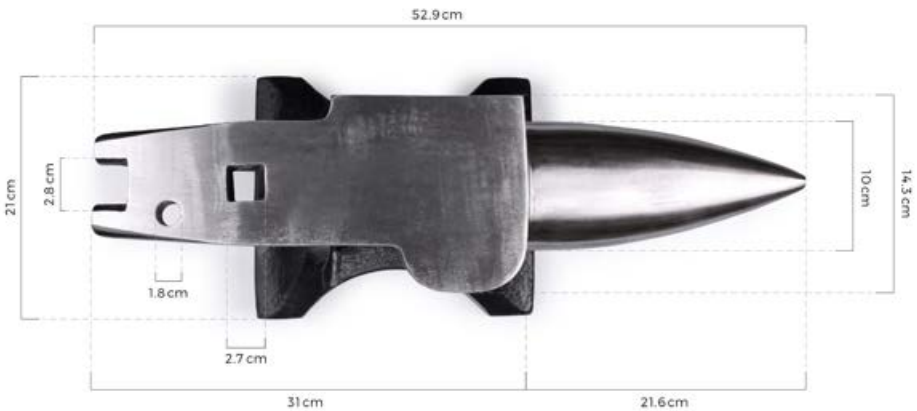





## Anvil Stands



### NC Folding Anvil Stand

---

- U Folds down to 7" (17.8cm) high in seconds, so it is easy to transport and handle
- U Made from strong tubular steel
- U Spring loaded vice on one side for holding shoes for rasping etc
- U Anvils are firmly secured using a hand crank lock down method. It can be adjusted to fit a variety of anvils



**[www.farrier-shop.com](http://www.farrier-shop.com)**

Visit our website for our latest product arrivals and special deals.

## Forges



### Blacksmith Forge

- U Ideal for making horseshoes or general blacksmithing
- U Well built solid forge complete with electric fan blower, water cooled tue iron etc
- U Plugs into a standard NZ power socket
- U 660mm wide x 840mm deep x 1080 tall
- U Working height 800mm
- U Weighs approximately 80kg



### Swan Single Burner Gas Forge

- U Very popular general purpose forge used by UK farriers
- U Front or rear exhaust options
- U Proven reliability and economy



### Whisper Baby Forge

- U Very portable single-burner forge with rear door to allow heating of long stock
- U Small forge for smaller shoes
- U Made in the USA



### Whisper Momma Forge

- U Open end model - it has open ports on the side which is ideal for heating steel bars etc
- U Double burner with front door
- U Spark lighter
- U Made in the USA by NC Tool



### Pro Forge PF200 Gas Forge

- U Double burner portable farrier forge
- U This forge is efficient, portable and ideal for the travelling farrier
- U Port on one side for heating bars
- U Made in USA by Cliff Carroll



### Knifemaker Forge

- U A double-burner farrier forge that allows for forging blades or damascus
- U Insulated doors on both ends for easy entry and removal of damascus billets, and allows for long pieces to be forged



### Whisper Benny Forge

- U 2 burner horse-shoer's gas forge
- U For fitting machine made shoes
- U Small exhaust port improves fuel consumption



### Whisper Lowboy Forge

- U A low profile three-burner farrier forge that is ideal for competition shoe making or forging damascus blades
- U Has an insulated door and open bar stock ports at each end



## Whisper Daddy Forge

---

- U 3 burner blacksmith's gas forge
- U Large firebox great for art objects, knifemaking and more
- U Open end ports for passing long bars through

## Forge Parts



## NC Tool Swing Out Arms

---

Swing out arm mounts for Whisper Low Boy, Whisper Daddy, Whisper Momma, and Deluxe forges.



## Pro Forge PF200 Swing Out Arm

---

Swing out arm mount for Pro Forge PF200.

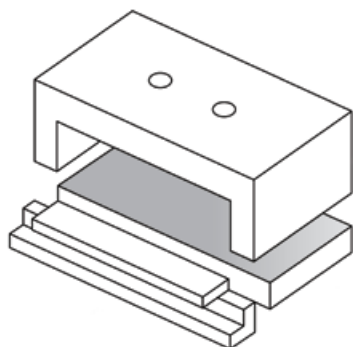

## Re-Liner Kits for NC Tool Forges

- U Reliner kits for various NC forges
- U Rebuild your forge if the liner is damaged or worn out



## Re-Liner Kit for the Pro Forge PF200

Kit includes:

- U Forge
- U Door liner
- U Gasket
- U Fire bricks



## Kaowool Forge Liner Blanket and Board

- U A ceramic fibre material used in the lining of forges and other high temperature applications
- U Suitable for continuous temperatures of 1260 degrees celsius
- U Sold by the metre (600mm wide and 25mm thick)
- U Kaowool board available by special request



## NC Tool Fire Brick

- U Fire bricks for the base of gas forges
- U Can be used to replace damaged fire bricks or on top of existing base bricks to avoid damage when fire-welding etc



## Blacksmith Coke

---

- U Coke for use in fixed blacksmith coke forges
- U 1000kg minimum order
- U This is a special order item from the UK

## Spare parts and rebuild kits

We supply spare parts and rebuild kits for most forges. Please ask us!

## Vices



## Valley Gooseneck Vice

---

- U Unique design of the vice jaw, together with a twist closure, gives the firmest hold possible
- U This vice is cast from chrome-moly steel and professionally heat-treated for strength and durability
- U Ideal for truck mounting or in the workshop



# HOOF CARE

## Hoof Adhesives and Applicators

### Equimix Adhesives

Equimix adhesives come in two-part 178ml tubes. They can be used with an existing 180cc/160cc Vettec style gun and mixing tips. A great cost-effective option.



#### Equimix Hoof Pad

- Designed to squirt on the horse's sole during the shoeing process to form an instant pad which bonds directly to the sole
- Offers the horse some shock absorption and comfort
- Must be used with mesh or pour pads



#### Equimix Hoof Pad CS

- The same formula as Equimix Hoof Pad but with added CS (copper sulphate)
- The CS pad material is infused with tiny copper sulphate crystals to ensure the frog and sole remains healthy whilst the pad is in place

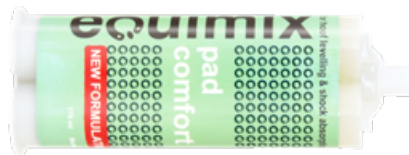

#### Equimix Hoof Pad Comfort

- The same formula as Equimix Hoof Pad but results in a softer, more comfortable pad



#### Equimix Ultra Fast Hoof Bond & Repair

- A fast setting bond and repair material which is ideal for repairing cracks, creating foal extensions, direct glueing of horseshoes and more
- The fast setting glue has an initial set time of around 35 seconds which makes it ideal when you need to get the glue setting quickly (for foals, nervous or fidgety horses etc). Full and final set occurs in around 5 minutes depending on temperature





## Vettec



### Vettec Equi-Pak 160cc

Dispensed directly onto the sole and frog, Equi-Pak is a liquid urethane that sets in 25 seconds.

- Can be used with or without a pad
- Provides support and protection for thin soled, flat footed horses, absorbs shock
- Can be filled to ground level for added support in less than one minute
- No hand mixing, no waste
- Will not breakdown, impervious to debris and moisture
- Sole and frog left in great condition



### Vettec Equi-Pak Soft 160cc

- About 2X softer than regular Equi-Pak
- Stays soft (even in cold temperatures)
- Strong bond to soles sealing out moisture and debris (better than silicones)
- Use with pads on working horses
- Perfect for deep commissures and thin soles
- Can be filled to ground level (w/o a pad) for lameness cases (with limited turnout)
- Absorbs shock and concussion



### Vettec Equi-Pak CS 160cc

Infused with copper sulphate, Equi-Pak CS effectively treats most minor cases of thrush.

- Can be used as a preventative measure during wet seasons
- Eliminates the need to pick out the feet and apply daily medication
- Sets in less than 1 minute
- Allows for faster, thicker hoofwall and sole growth
- Provides same protection and support as original Equi-Pak



### Vettec Adhere 160cc

Adhere is a fast-setting urethane adhesive designed to bond aluminum or steel shoes to the hoof and to fabricate hoof wall repairs.

- Glue on steel, aluminum and most plastic shoes as well as any hoof repair project
- Initial set time of one minute and final cure time of six minutes
- Sets hard with a superior bond, but maintains the flexibility necessary at the quarters and heels to allow the natural movement of the hoof
- Available in black and beige



## Vettec Sole-Guard 160cc

- Offers fast and effective protection and support for the unshod foot
- Sole Guard is used to fill the bottom of the foot, creating a protective coating that bonds to the foot for up to three weeks
- Sole-Guard sets firm to protect the unshod foot, but retains flexibility to move naturally with the foot, providing comfort and support



## Vettec SuperFast 160cc

30-second set, all-in-one hoof adhesive.

- Making foal extensions is easy
- Create a custom shoe in minutes
- Hoof repairs completed in minutes

## Vettec mixing guns and tools



## Vettec Dispensing Gun

Dispensing gun which is required for all Vettec 160cc products.



## Vettec Battery Powered Dispensing Gun

Battery powered dispensing gun for Vettec 160cc products.

Easy to use, quiet and needs fewer hands to operate compared to regular hand guns.

Supplied with two batteries.



### Vettec Large Mixing Tips

Large mixing tips for Vettec 160cc products.



### Vettec Equi-Mesh

Support Mesh for packing material, black (6" x 8").

Roll out between the shoe and the hoof before applying EquiPak products.



### Blue Foam Board

- Easy to apply
- Seals and supports Equi-Pak until set
- Recesses material from ground level for traction
- Evenly distributes material over solar surface
- No material ends up as a "high" point to create sole pressure
- Reduces the time spent holding the hoof up
- Easy to remove



### Contouring Plastic for Sole Guard

Translucent lightweight plastic material that can be utilised to push the product into the voids. Particularly useful when applying Sole Guard.

- Used after applying Vettec products to smooth and level the material
- Will not stick to Vettec products and can be discarded after use

## Equilox

### Equilox Adhesive System

Equilox is an extremely strong resin that can be used for anything from repairing small quarter cracks to reconstructing an entire hoof wall, yet flexible enough for easy filing, shaping, and even nailing.

- U Comes in: single use 1oz (28.5ml) pots, 150ml (5oz) stubbies, and 400ml (14 oz) tubes
- U Set time: Sets in 6 - 8 minutes, final cure in 10 - 13 minutes at 21° C (70° F)
- U Shelf life: At least 6 months from fill date (as stated on label) — or longer if refrigerated
- U Available in black or tan
- U We also stock mixing guns in regular and mini size for applying Equilox, as well as mixing tips and applicator sticks



400ml (14oz)  
Side-by-Side Gold



Stubbie 150ml (5oz)



Single use pot



## Equilox Mixing Guns and Tools



### Equilox 400ml Dispensing Gun

- U Equilox Side-by-Side (Gold) applicator gun
- U Fits Equilox 400ml (14oz) cartridges



### Equilox Large Mixing Tips

- U Large mixing tips for Equilox 400ml (14oz) and Stubbie 150ml (5oz) cartridges

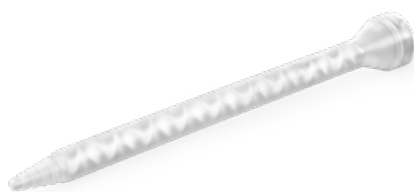

### Equilox Stubbie Mixing Tips

- U For use with Equilox Stubbie 150ml

# HOOF CARE

## Other Adhesives



### Hoof-Life

- U Modern adhesive designed to withstand the rigours of competition horses as well as assisting in hoof rebuilding
- U 4 - 6 minutes curing time
- U Available in 420ml cartridges
- U Mixing tips sold separately

## Silicone and Applicators



### Vettec Sil-Pak 160cc

- Dispense under a pad to cushion, seal and protect the equine foot.
- U Weight bearing in 2 minutes
  - U Totally fills and seals all void areas
  - U Auto-mixing ensures consistent set times
  - U Ensures complete coverage of sole
  - U Prevents debris migration
  - U Use Vettec 160cc mixing gun and tips
  - U Economical application



## MV2

### MV2 Silicone System

---

A range of 200ml silicones for use under hoof pads for a variety of uses.

Ultra Soft (10 shore A) - recommended for highly sensitive soles.

Enduro (12 shore A) - soft silicone that has four times the mechanical resistance compared to the Ultra Soft. Injected under the pad, the material stays in place and holds its position even under extreme conditions. Ideal for endurance horses and those working on hard or irregular ground.

Comfort & Shock Absorbing (18 shore A) - as the name suggests, enables a shock absorbing cushion under the pad for optimal load distribution to reduce concussion. Ideal for sore horses.

Firm Kinesitherapeutic (25 shore A) - providing kinesitherapeutic support to the sole to help with under-slung heels and to assist with growth of heel.

Hard Kinesitherapeutic (50 shore A) - extra hardness for use on laminitic equines and remedial cases.



# HOOF CARE

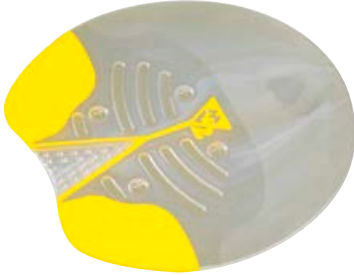

## MV2 Dynamic Pads

- U A bi-density hoof pad with shock absorbing properties on the heel
- U Combines special non-return valves in the pad for the injection of MV2 silicones (using the MV2 mixing tips)
- U Transparent pad so you can see silicone packing injected under the pad
- U Fill different zones of the foot with several hardnesses of silicone as required



## MV2 Dispensing Gun

- U Dispensing gun for MV2 silicone system



## MV2 Mixing Tips

- U Mixing tips for use with the MV2 silicone system

## Hoof Repair



## Hoof Staples

Pack of 10 steel hoof staples for outer hoof wall crack repair.

Available in sizes:

- U 3/16" (5mm)
- U 1/4" (6mm)
- U 5/16" (8mm)





## Hoof Repair Fabric

For use with acrylic and adhesives when repairing hooves. 12" in length.

These fabric materials can be cut into shape and used to add strength to a hoof repair when using glues.

Available in three types:

- U Polyester - high strength braid (1 1/2" tube)
- U Cobrasox - ultra high strength braid (carbon fibre/kevlar) (1 1/2" tube)
- U Poly-Vectran - abrasion resistant, high strength braid (polyester/liquid crystal polymer) (4" wide tape)



## Hoof Crack Sutures

- U Suture kit for repairing cracks in the hoof wall
- U Kit contains 8 stainless steel sutures with backing plates, pre-threaded and 8 extra stainless steel backing plates



## Farrier Shears

High carbon steel, Rockwell 72 degrees, hard chromed with high leverage grips and short powerful serrated jaws.

Ideal for cutting hoof repair fabric.



## Aluminium Crack Plate

Ideal for gluing or screwing onto the hoof wall to assist with the repair of difficult cracks.

- U 3 1/4" x 2" (83mm x 50mm)
- U Glue and screws not included



## Hoofcast

Hoofcast is a versatile hoof cast system which is simple to apply yet very effective.

Applied in a similar way as you would apply a regular hoof bandage, Hoofcast sets hard within minutes with the finished result similar to a cast applied to human broken bones.

Hoofcast can be applied within minutes by vets, farriers or horse owners for:

- U Adding a temporary hoof dressing for foot injuries
- U Providing comfort to tender footed horses (or those transitioning to barefoot)
- U Support to the hoof wall in laminitic and founder cases
- U The repair of poor or damaged hoof wall
- U To keep a loose shoe in place in an emergency
- U Temporary protection to the hoof when a shoe is lost
- U Hoofcast can be used on a barefoot horse, under a shoe (the farrier can nail through it) or over a shoe to help hold the shoe in place

One roll per hoof is required and available in:

- U 2" (50mm) wide
- U 3" (75mm) wide
- U 4" (100mm) wide



## Hoof Screws

Set of 40 small screws for screwing hoof repair plates, patches or other crack repair devices to the outer hoof wall.

Mixed sizes and head types.



## Michael Puhl Hoof Clip

---

For repairing cracks, the regular PM Hoof Clip has a mechanism that can be tightened or expanded for maximum control of crack stability levels.

The stainless steel clip comes complete with 2 attachment screws and wrench for adjusting the tightness of the clip.



Regular hoof clip



Heel hoof clip



Butterfly hoof clip

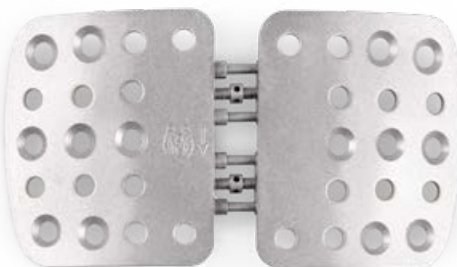

Toe hoof clip

## Hoof Packing



### EquiFlex-Pak

- The SoundHorse 2-part silicone packing is specifically designed for the rigors of hoof packing application and is “gas permeable”. This unique property allows treatment materials (e.g. copper sulphate) when mixed with the silicone to slowly pass through the cured silicone as a treatment
- Two-part silicone, 1:1 mix ratio with a quick set time
- 3lb (1.36kg) boxed kit



### Michael Puhl Hoof Packing

PM Hoof Packings are high-tech two-component silicones that are easy and clean to work with (you do not need gloves). Compared to many other hoof packings on the market the PM hoof packings do not stick to hoof and pad and do not hamper the foot's natural function and balance in locomotion.

Available in regular and soft. The PM Hoof Packing Soft is soft, lightweight and shock absorbing, ideal for feet that are sensitive to sole pressure.

Extremely lightweight and particularly shock-absorbing 'high tech' A+B component kneading silicone. Mixture ratio 50:50, curing time: 2-3 mins.

Particularly appropriate for coffin joint inflammation and generally sensitive hoof sole, for navicular syndrome, corium inflammation, diseases of the deep digital flexor tendon, contracted and under-run heels, coffin joint arthritis, laminitis/founder and hoof cracks.

The PM Hoof Packing Soft has also been tried and tested in combination with hoof boots as an additional insole. It ensures that the boot fits perfectly with optimal shock absorbance and pressure distribution.

MP Soft available in:

- A+B 0.7kg and 1.4kg

MP Regular available in:

- 1.5kg



## Hoof Pads



### Black Rubber Hoof Pads

- Provides cushioning and protection
- One size fits all - cut to size with your hoof nippers or a sharp knife
- 6" wide x 6 1/2" long
- Sold by the pair



### Castle Plastics Mesh Pour Pads

Firm plastic mesh pads for use with liquid hoof packing materials.

Size: 6" wide x 6 1/2" long.



### Castle Oval Wedge Pads

Urethane wedge pads available in 1, 2 and 3 degree wedges.

Size: 6" x 7".



### Castle Frog Support Pads

Hoof pad with raised frog piece to apply pressure to the frog.

Available in:

- Flat
- Wedge

Available in sizes:

- Small
- Large



## Michael Puhl Flat Pads

The PM flat pad is an aid to eliminate increased strain on tendons, heels and soles.

To restore the hoof-balance by pressure distribution.

Tendon-supporting effect due to frog-shaped concavity – leading to a statics/balance improvement similar to the one of a closed-bar shoe (e.g. egg-bar shoe). The empty space between hoof and the PM Hoof Pad Flat can then be filled with PM Hoof Packing, Regular or Soft.

Size	Width	Length	Thickness
------	-------	--------	-----------

One size	180mm	183mm	3mm
----------	-------	-------	-----



## Michael Puhl Wedge Pads

To restore the hoof-balance by enlarging the weight bearing area.

Tendon-supporting effect with frog-shaped concavity. An extra benefit of the PM wedge pad is the enlargement of the weight bearing area of the heels that results in an optimized weight and pressure distribution. By lowering the heels, the weight-bearing area is substantially increased.

Available in medium and large sizes and can be cut to shape.

Size	Width	Length	Thickness
------	-------	--------	-----------

Medium	145mm	150mm	9mm
--------	-------	-------	-----

Large	180mm	185mm	10mm
-------	-------	-------	------



**Instagram - @farrier\_shop**

Follow us on Instagram to see photos of our latest products!



## VFT Supreme Pads

---

Viking Farrier Tools' revolutionary Supreme hoof pads provide support, protection, shock absorption and comfort.

The pads have a concave sole which allows for some grip when the horse is working on soft surfaces, and the frog support allows the pads to flex over the frog whilst offering support.

All pads have one way silicone application ports in the ground surface. Most common cartridge based silicones and liquid hoof padding materials (Vettec EquiPak, MV2 etc) can be applied once the pad is in place on the foot.

Available in:

- U 30 shore (blue) is the softest pad in this range
- U 50 shore (green) is medium rated
- U 70 shore (orange) is the firmest of the types

Comes in two sizes:

- U Regular (135mm)
- U Large (165mm)



## Shocktamer Pads

Shocktamer horse hoof pads feature a dual density polyurethane which allows the pad to both absorb and dissipate concussion.

The grey material is raised slightly above the black and absorbs concussion, while the harder black material dissipates it away from the hoof and the leg.

Available in:

- Medium: 150mm x 140mm, 4mm thick



## TTM Frog Support Pads

A high quality pad with added frog support.

Available in:

- Flat small: 4 3/4" x 5"
- Flat medium: 5 1/2" x 5 7/8"
- Flat large: 6 1/4" x 6 1/2"
- Wedge medium: 5 1/2" x 5 7/8"
- Wedge large: 6 1/4" x 6 1/2"



## Razer ProPad

The Razer ProPad has been designed with a flexible frog-support to fill the void between hoof frog and ground when the horse is shod.

ProPad can reduce injuries and increase performance.

Can be used with the Razer horseshoes or with other brands of shoe.

Available in:

- Support small: 4 7/8" x 5 3/8"
- Support medium: 5 1/2" x 5 7/8"
- Soft Support small: 4 7/8" x 5 3/8"
- Soft Support medium: 5 1/2" x 5 7/8"
- Soft Support large: 6" x 6 3/8"

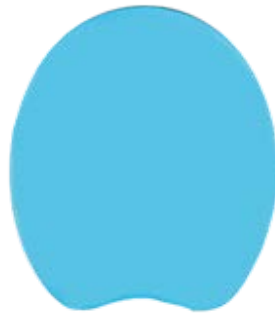

## Kerckhaert Blue Race Pads

Size: 6" x 6 1/2".





### Luwex Flat Pads

Made from a proven shock absorbing material.

The integrated mesh is great for applying hoof packing materials (EquiPak etc).

Available in:

- ⊖ Flat: 6 1/2" x 6 1/2"
- ⊖ 2 degree wedge: 6 1/2" x 6 1/2"



### Hospital Open-Up Pad

This hospital pad is made from a hi-tech material and has a cap (to enable cleaning and medication of the wound) that can be fixed and removed with the special key provided.

Size: 7 1/4" x 8 1/4".



### Castle Draft Horse XXXL Pads

For the larger horse.

Size: 9 3/4" wide x 9 3/4" long, 5/16" thick.



### Keystone Leather Pads

Leather conforms naturally to the hoof and allows breathability for the hoof sole while maximising protection.

Available in:

- ⊖ Light
- ⊖ Regular
- ⊖ Heavy



## DePlano Leather Pads

Premium Italian leather hoof pads. Allow for some breathing of the foot without compromising on protection and shock absorption. Measure 170mm x 190mm.

Available in the following thicknesses:

- U Light: 3 to 3.5mm
- U Regular: 4 to 4.5mm



## Thermo Pads Race & Sport

When heated, thermo pads become mouldable to follow the contours of the sole and frog providing protection, support and comfort.

Available in:

- U Sport (blue): 14 x 14cm
- U Sport (blue): 20 x 20cm
- U Race (white): 14 x 14cm
- U Race (white): 20 x 20cm



## Flip Flop Pads

For the harness racing horse with sore knees.

Open eye design makes it easier to clean under the pad when it is on the foot.

Available in 5 sizes:

- U 1 (4 5/8" x 5 1/4" wide)
- U 2 (5" x 5 3/4" wide)
- U 3 (5 1/4" x 6" wide)
- U 4 (5 3/4" x 6 1/2" wide)
- U 5 (6" x 7" wide)



## Flapper Race Pads

Open centre flip flop pads for harness race horses. Lighter in weight than the full flappers.

The open centre allows for dirt and debris to exit the sole compared to a full pad which can trap dirt underneath.

Available in 3 sizes:

- U 2 (5" wide)
- U 3 (5 1/4" wide)
- U 4 (5 3/4" wide)

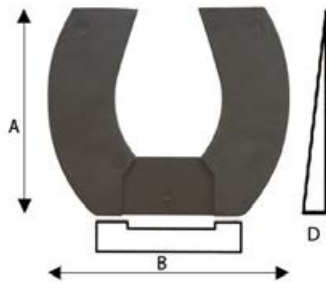

## Plastic Heel Wedges

Used for raising the heel.

Available in:

- Size 2 (5  $\frac{9}{16}$ " x 4  $\frac{9}{16}$ ", 11mm thick at heel)
- Size 4 (6  $\frac{3}{8}$ " x 5  $\frac{3}{4}$ ", 12mm thick at heel)



## Castle Bar Wedge Pads

- Graduated plastic wedge pads
- Slide under the shoe during the shoeing process to get a degree increase at the heel
- Available in sizes 2 and 4



## EVA System Pads

Used to treat laminitis. Designed to minimise shock and reduce leveraging at point of breakover.

Available in:

- Size 000: 4  $\frac{1}{4}$ "
- Size 00: 4  $\frac{1}{2}$ "
- Size 0: 4  $\frac{3}{4}$ "
- Size 1: 5"
- Size 2: 5  $\frac{1}{4}$ "



## Styrofoam Support Pads

Pre-cut, hoof shaped pads made of a very dense Styrofoam. When applied, the Styrofoam compresses into the caudal portion of the foot and offers the horse comfort, support, and protection. Excellent for use with laminitic horses and ponies.

Available in:

- Small: 5" x 5  $\frac{1}{2}$ ", 48mm thick
- Medium: 5  $\frac{1}{4}$ " x 6", 48mm thick
- Large: 5  $\frac{1}{2}$ " x 6  $\frac{1}{2}$ "
- XL: 6" x 7"

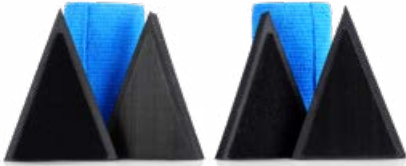

## Beanie Frog Aid Kit

---

A first aid treatment for acute laminitis, which can be used to apply support to the frog in the initial stages of foundering horses or ponies.

The unique velcro surface allows you to add or remove additional frog pads easily depending on how much pressure is required.

Contains enough for two feet and supplied with two vet-wrap bandages to make application of the pads quick and easy.



## Beanie Frog Aid Medical Support System

---

A full-pad first aid treatment for laminitis, which is designed to be vet-wrapped on to the hoof for sore horses.

The separate velcro frog pads can be stuck on to the pad for extra frog-pressure with the intention of adding extra support, and as a result, some pain relief.

Includes 2 full soft pads and 2 soft frog velcro pads.



## Kevin Bacon's



### Kevin Bacon's Hoof Formula Supplement

- U Arguably the best performing hoof supplement available in NZ
- U Highly palatable
- U Contains a broad range of ingredients for improved hoof growth

Before:

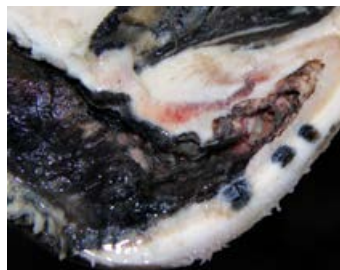

After 6 weeks:



The results speak for themselves.



### Kevin Bacon's Liquid Hoof Dressing

- U 100% natural ingredients
- U Made in Belgium
- U Helps maintain moisture content within the hoof
- U Integrated brush inside the lid
- U Available in 500ml, 1 litre and 5 litre



### Kevin Bacon's Natural Hoof Dressing

- U The original hoof dressing in the range
- U In balm form - apply using brush
- U Available in 1 litre, 2.5 litre, and 5 litre tubs





### Kevin Bacon's Hoof Solution

- U Very effective for treatment and prevention of thrush
- U 100% natural ingredients
- U Non-toxic
- U Also effective for over-reaches



## Kevin Bacon's

horse care products can be found on page 182



### KEVIN BACON'S HOOF SOLUTION

To keep the foot healthy, apply Kevin Bacon's Hoof Solution onto the frogs and soles before fitting pads.



**1** Clean hoof



**2** Apply Kevin Bacon's Hoof Solution over frog and sole



**3** Fit pad and shoe

## Hoof Treatments

### Keratex



### Keratex Hoof Hardener (250ml)

- Apply to the outer hoof wall
- Improves the strength of the hoof
- Works well for thin soled horses
- A popular seller

### Keratex Mud Shield Powder (450g)

- For mud related conditions
- Easy to use puffer bottle
- Anti-bacterial
- Applied to legs for protection



### Keratex Hoof Putty (200g)

- For plugging holes and cavities in hoof
- Slowly releases anti-bacterials
- No need for pad or shoe





## White Lightning



### White Lightning Gel 60ml

- U Eliminates seedy toe and thrush
- U Multiple treatments per bottle
- U Safe to use – doesn't attack healthy tissue
- U Easy to use squirty bottle
- U No need for soaking, just apply and leave to work for 35 minutes



### White Lightning Liquid 8oz

- U When mixed with white vinegar, it produces a gas which is very aggressive in neutralising bacteria, fungus and yeast
- U Effective in the treatment of minor cases of seedy toe (white line disease) and thrush in horses hooves
- U Harmless to healthy tissue

## Magic Cushion



### Magic Cushion

- U Hoof packing
- U Helps relieve symptoms associated with concussion and trauma
- U Soothing relief
- U Fast acting, long lasting
- U Available in 4lb (1.8kg) and 28lb (12.7kg)



### Magic Cushion Xtreme

- U Hoof packing
- U Higher concentration of active ingredients than regular Magic Cushion
- U Calms sore soles and frogs
- U Available in 4lb (1.8kg)

# HOOF CARE

## Hawthorne



### Hawthorne Hoof Freeze 8oz

- ⊖ Prevents and soothes pain and soreness in hooves
- ⊖ Apply prior to racing or competing



### Hawthorne Sole Pack Paddies 2oz

- ⊖ Continuous medicated relief for dry hard hooves
- ⊖ Combats bacterial and fungal infections
- ⊖ Fast acting, quick penetrating



### Hawthorne Sole Pack 4lb Tub

Same formulation as Sole Pack paddies but in a convenient bulk 4lb tub



### Hawthorne Sole Pack Liquid

- ⊖ Medicated liquid hoof dressing
- ⊖ Combats bacterial and fungal infections
- ⊖ Available in 32oz and 16oz



### Hawthorne Wind Aid 1oz

- ⊖ Concentrated 1oz tube – single dose
- ⊖ Relieves seasonal allergies, coughs and respiratory tract problems



### Hawthorne Wind Aid 32oz

- ⊖ Relieves coughs, allergies and minor breathing problems
- ⊖ Administered orally
- ⊖ One dose is 2oz



### Silver Thrush

A natural product in the prevention and treatment of thrush with added benefits.

Containing medical silver, natural clays, iron salts and natural salts, Silver Thrush powder is effective and easy to use with the puffer bottle.

Use around the frog area for thrush, or on affected areas for mud fever. It can also be used as a wound powder.

Available in 100g and 200g puffer bottles.



### NT-Dry 70g

- ⊖ For treatment of thrush
- ⊖ Fast and effective
- ⊖ Dry application from puffer bottle



## Thrushbuster (2oz)

- For use on frogs against thrush
- Squirty bottle
- A popular seller



## Hoof Stretch Wrap

- For use in various hoof adhesive procedures.
- Wrap and handle sold separately.

## Hoof Boots

### HOW TO MEASURE HOOVES TO DETERMINE BOOT SIZE

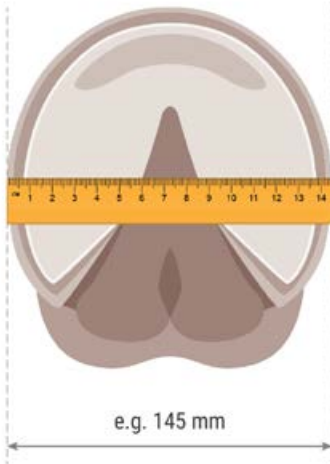

Measure the width of the hoof at its widest point.

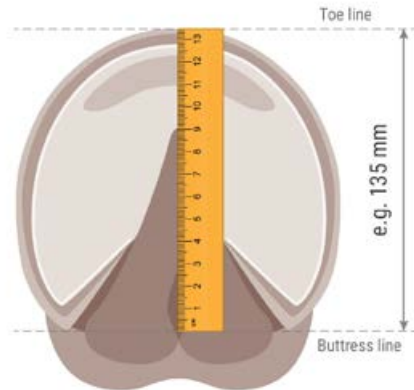

Measure the height of the hoof between the toe line and the buttress line.



## Cloud Therapy Boots



Acclaimed "The Most Robust Therapeutic Boot In The World", the Easyboot Cloud offers relief, support and increases comfort to equines suffering from laminitis, bruising of the sole, working on hard ground, hoof infections and chronic lameness. The instant and ongoing relief encourages movement and therefore recovery following injury or surgery. Sold individually.

Boot size	Width (mm)	Length (mm)
2x0	89 - 98	101 - 111
0	98 - 108	111 - 117
1	108 - 124	117 - 130
2	124 - 133	130 - 136
3	133 - 149	137 - 150
4	149 - 159	150 - 159
5	159 - 170	159 - 170
6	170 - 177	170 - 177

## EasyCare Cloud Therapy Boot Pads



Spare replacement pads for the EasyCare Inc Cloud Therapy Boot. Comfort pads are made from EVA material which conforms to the hoof providing support and comfort inside the boots.

Available to fit Cloud boot sizes 2x0 - 6.

Sold in pairs.

## EasyCare Mini Hoof Boots



Mini hoof boots for the particularly tiny hoof.

Sold individually.

Boot size	Width (mm)	Length (mm)
1	50 - 55	55 - 64
2	56 - 65	65 - 72
3	66 - 76	73 - 86

## Comfort Pads



EasyCare EVA foam comfort pads are designed to fit inside Old Mac's hoof boots to provide additional comfort and shock absorption. They are excellent for horses who are sore and need extra softness and/or frog support.

The pads come in two thicknesses - 6mm or 12mm and may be stacked inside the boots.



## Scoot Hoof Boots



- U Easy on easy off
- U Will not get soggy, heavy or wet when riding through muddy and wet terrain
- U Superb strength over all types of terrain
- U Superior traction
- U No cables or Velcro
- U Lightweight — only 250g
- U Great ventilation and breathability for hot climate riding
- U Excellent drainage
- U Easy to clean
- U Will fit hooves securely throughout a trimming cycle
- U No adjustment is required as the boot is secured by parts of the hoof that do not grow
- U Will last approximately 1000km but this will depend on the type of terrain and your horse's movement

Sold by the pair.

Scoot Boot sizing shells available for loan.

Scoot Boot Mud Straps (2 pack black) also available.

### Boot size    Width (mm)    Length (mm)

Boot size	Width (mm)	Length (mm)
Mini 1	75 - 90	80
Mini 2	80 - 95	85
Mini 3	85 - 100	90
3x0	90 - 105	95
2x0	95 - 110	100
0	105 - 115	105
1	110 - 120	110
2	115 - 125	115
3	120 - 130	120
4	125 - 135	125
5	130 - 140	130
6	135 - 145	135
7	135 - 150	140
8	140 - 155	145
9	145 - 160	150
0 Slim	95 - 105	105
1 Slim	100 - 110	110
2 Slim	105 - 115	115
3 Slim	110 - 120	120
4 Slim	115 - 125	125
5 Slim	120 - 130	130
6 Slim	125 - 135	135

# STUDS







## Pro Grip Studs



PGS-HG6



PGS-HG10



PGS-HG14



PGS-HG16

### PGS - Hard Ground 3/8" Thread

- U Self-clearing stud system
- U Tungsten pin
- U For traction, safety and peace of mind
- U Sold in packs of 4 studs

Stud size	Protrusion (mm)
HG6	6
HG10	10
HG14	14
HG16	16



PGS-SG9



PGS-SG13



PGS-SG17



PGS-SG21

### PGS – Soft Ground 3/8" Thread

- U Self-clearing stud system
- U Tungsten pin
- U Available in SG9 (9mm), SG13 (13mm), SG17 (17mm), SG21 (21mm)

Stud size	Protrusion (mm)
SG9	9
SG13	13
SG17	17
SG21	21

# STUDS



RP12



RX16



RS16

## Rescue Studs

- U Designed to tighten up and hold firmly in 3/8" stud holes that have become worn or slack
- U Should be an essential part of every competitors stud kit - just in case
- U Use a coin or screwdriver in the slot to screw in Rescue Studs if you don't have a spanner at hand
- U 4 Rescue Studs per pack

Currently available in three styles:

- U Type P (RP12) - The shortest of the Rescue Stud range
- U Type S (RS16) - For harder ground
- U Type X (RX16) - For softer ground

Stud size	Protrusion (mm)
-----------	-----------------

RP12	12
RX16	16
RS16	16

## Stud Accessories



### PGS – Spanner Key

- U Fits all new style Pro Grip Studs
- U For fitting and removing studs in the horseshoes



### PGS – Magnetic Stud Dish

- U Magnetic dish for storing all studs before, during and after the competition
- U Makes fitting and removing studs easy
- U Saves dropping studs in the mud



### **PGS – 3/8" Flush Fitting Keepers**

---

- U For use in between competitions to keep the stud holes clean and the thread intact
- U Sold in packs of 8
- U Fits a 3/16 allen key (also available)



### **PGS - Foam Stud Hole Plugs**

---

- U Foam 3/8" stud hole plugs to keep stud holes clean between uses
- U Sold as foam board with 50 plugs each board



### **PGS – Steel Threaded Inserts**

---

- U Steel threaded inserts for stud holes in aluminium shoes
- U Drill 12mm hole then fit insert into hole



### **PGS – Thread Cleaning Tool**

---

- U An ingenious tool to remove dirt from the threaded stud hole of the shoe
- U Quick and easy to use at a show or competition to clear the thread, making the job of putting studs in easier

# EDUCATION

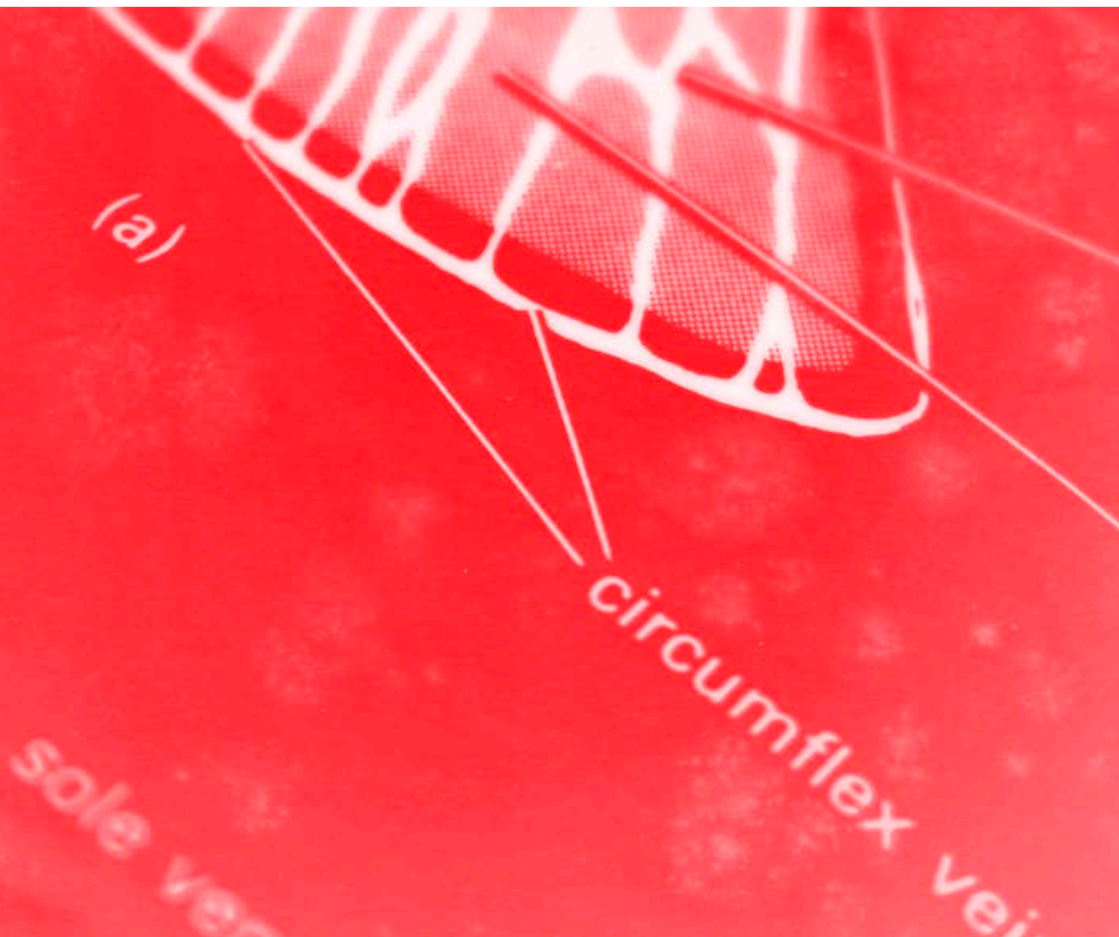



## Books



### American Farriers Journal

---

American Farriers Journal is the leading journal for farriers in the US and around the world.

Sold per issue. Back issues also available.

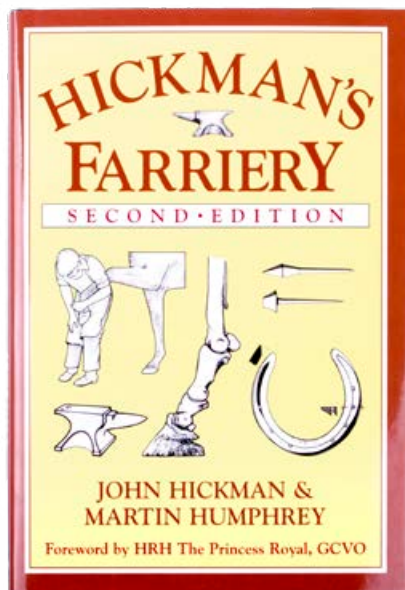

### Hickman's Farriery 2nd Ed.

---

The new edition demonstrates how traditional skills can be combined with modern science to benefit the welfare, soundness and performance of the horse.

Explanations of the underlying structure of the horse's front and hind legs help farriers to better understand the scientific principles of their craft.

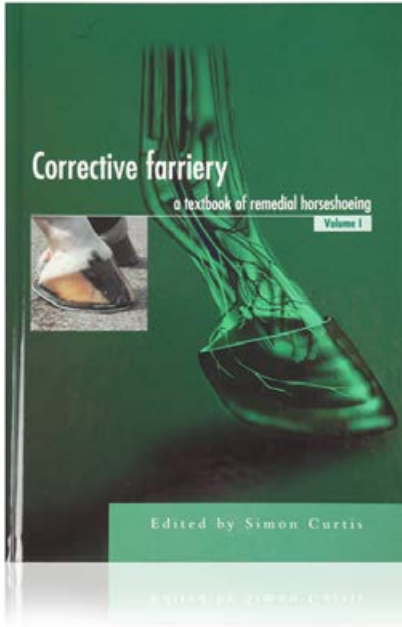

## Corrective Farriery Volume I

Edited by Simon Curtis FWCF HonAssocRCVS

The book describes the combining of traditional farriery skills with veterinary knowledge and advanced techniques of repair and shoeing.

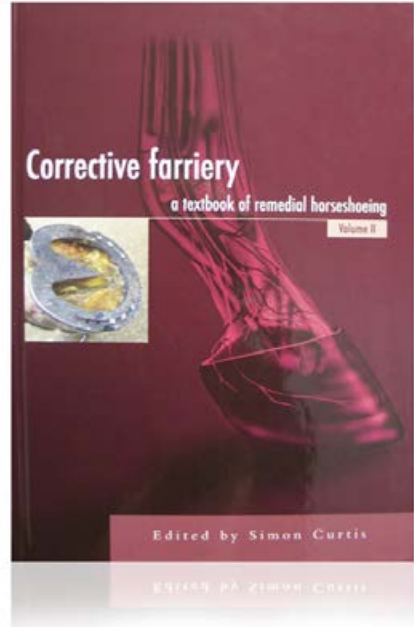

## Corrective Farriery Volume II

Edited by Simon Curtis FWCF Hon AssocRCVS

Corrective Farriery Volume II completes a 2-part work covering all aspects of remedial shoeing and the associated background knowledge. Corrective Farriery starts with what is probably the most detailed anatomy of the equine hoof ever published.

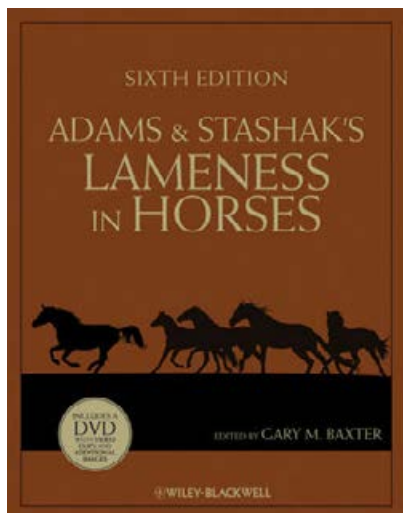

## Adams Lameness in Horses

---

The Sixth Edition of Adams and Stashak's Lameness in Horses builds on the book's reputation as the classic gold-standard reference on equine lameness.

Now in full color, the text has been fully revised and streamlined to improve user-friendliness, with a new, simplified format and a stronger emphasis on the diagnosis and management of lameness. It includes a supplemental DVD.

Available by special order only.

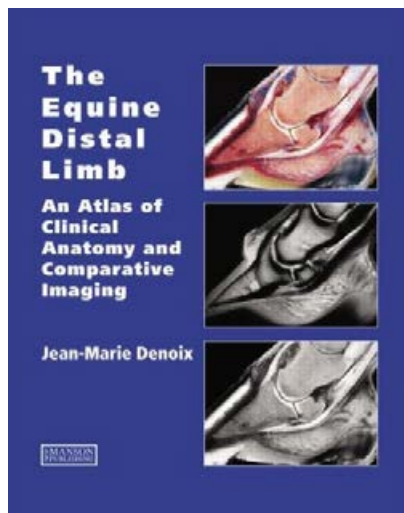

## The Equine Distal Limb

---

By Jean Marie Denoix

This book provides a unique contribution and will be an invaluable reference text. The book is designed for maximum clarity using a generous page size. The atlas will be essential for anybody involved in detailed anatomical study, complex lameness evaluation or advanced imaging techniques.

Available by special order only.

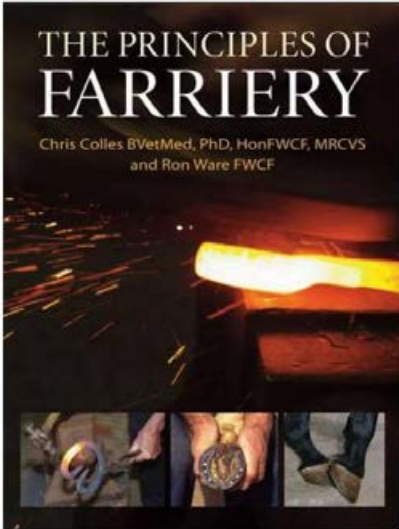

## Principles of Farriery

By Chris Colles BVetMed, PhD, HonFWCF, MRCVS and Ron Ware FWCF

Essential reading for all trainee farriers and useful reference book for qualified farriers and vets.

Anatomy, shoe-making, modern farriery practice, foot and gait problems and remedial shoeing.

Includes over 400 illustrations with clear colour drawings and diagrams.

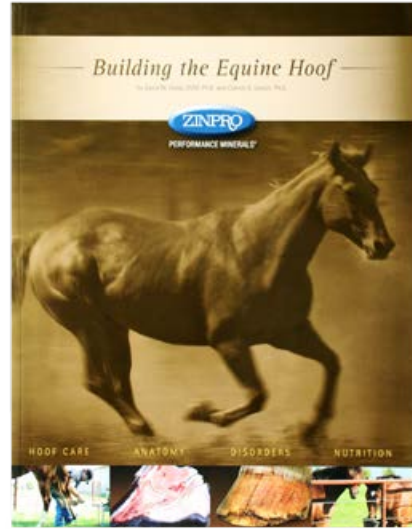

## Building the Equine Hoof

By David M Hood, Connie K Swenson and A Bruce Johnson

An excellent 45 page resource with chapters on hoof care, anatomy, growth and nutrition, disorders and diseases.

The standout feature of this book is a series of semi-transparent pages enabling the reader to see where and how the bones fit together inside the hoof.



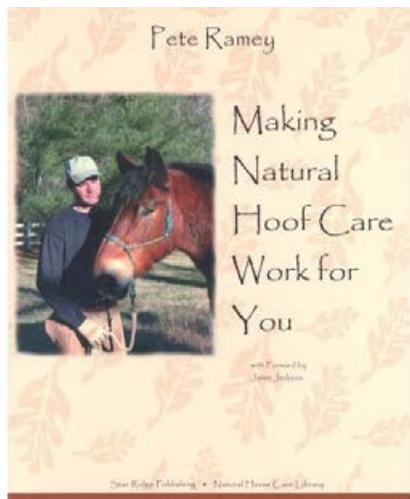

## Making Natural Hoof Care Work For You

---

By Pete Ramey

Making Natural Hoof Care Work for You is intended for horse owners, vets and of course, hoof care providers wanting "straight talk" and reliable information on how to "cross-over" into natural hoof care.

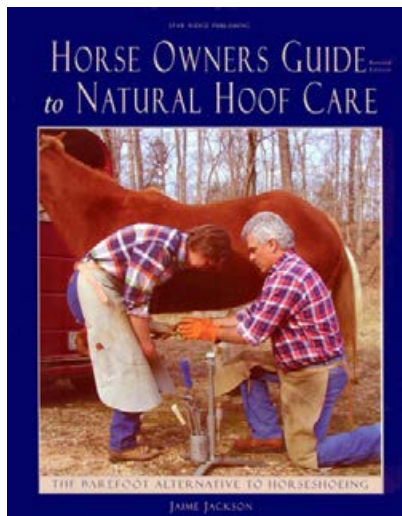

## Horse Owners Guide to Natural Hoofcare

---

By Jaime Jackson

This book features step-by-step instructions for the natural trim based on the wild horse model. Written for horse owners who want to improve their understanding of natural hoof care, and also for farriers wanting to transition to natural hoof care.

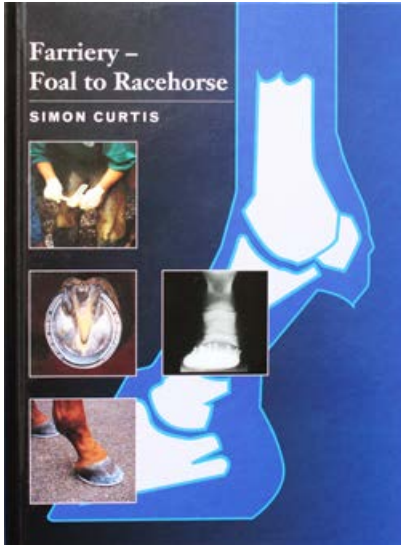

## Farriery - Foal to Racehorse

By Simon Curtis FWCF

This book is for farriers, veterinary surgeons, trainers and breeders. It describes farriery involvement, from the newborn foal to the horse in training and back to the stud farm.

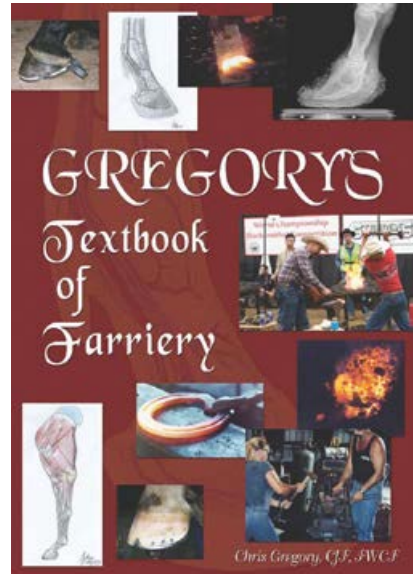

## Gregory's Textbook of Farriery

By Chris Gregory, C.J.F, FWCF

Gregory's Textbook of Farriery is a tremendous work on the craft and art of farriery. No one involved with horses should be without this great book.

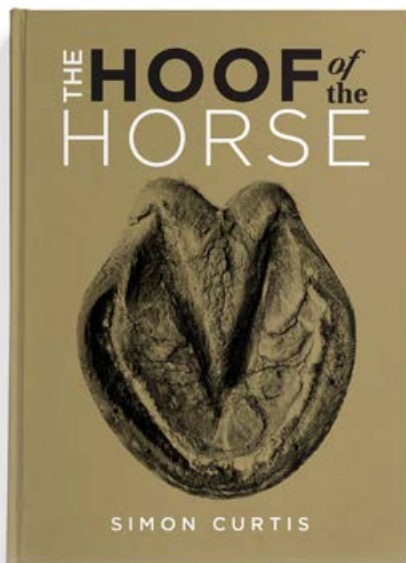

## The Hoof of the Horse

---

By Simon Curtis.

With over 250 colour illustrations, this latest book from Simon Curtis is filled with practical information and is on the must-read list for farriers, trimmers and anybody with an interest in the equine hoof.

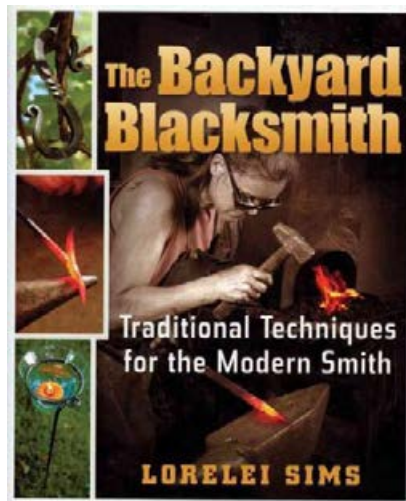

## The Backyard Blacksmith

---

The Backyard Blacksmith: Traditional Techniques for the Modern Smith by Lorelei Sims

174 pages of how to make some simple tools and other useful items.

Full colour photos, instructions and illustrations.

The author, Lorelei Sims, is an experienced smith who runs Five Points Blacksmith Shop in Charleston, Illinois.

## DVDs

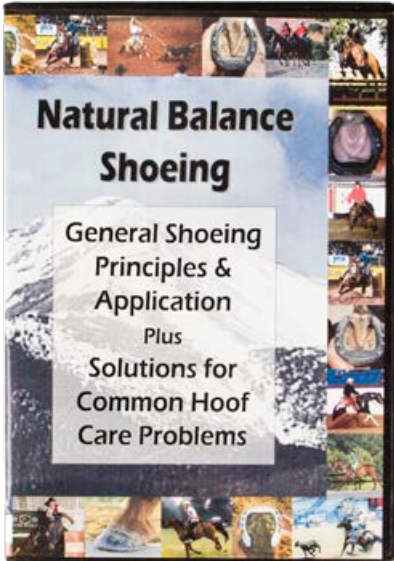

### Natural Balance Shoeing

By Gene Ovnicek

This DVD gives those interested in Natural Balance some comprehensive information regarding Natural Balance hoof preparation, application of Natural Balance Shoes, Pads and Impression Material. It also offers some instruction for horses with mismatched feet, underrun and contracted heels, as well as horses that are base narrow or pigeon toed.

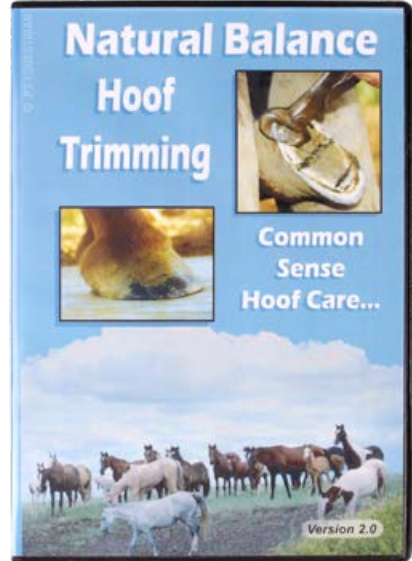

### Natural Balance Hoof Trimming

By Gene Ovnicek

This video will give you new insight and direction into the maintenance of the equine foot and the many factors that need to be considered when natural hoof trimming techniques are employed. It will also help you understand the needs of the equine hoof, as well as assist you in determining whether your horse can comfortably go without shoes in his domestic environment and perform at his expected level of use.

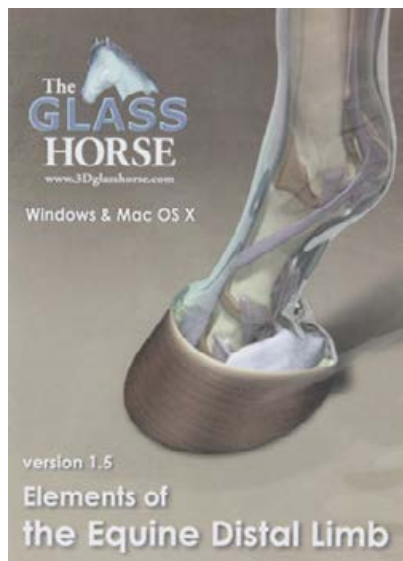

## The Glass Horse

---

An engaging interactive exploration of the equine distal limb that combines interactive models with informative narrations and highly detailed animations. The interface allows manipulation of anatomical models in three dimensions.





## Hoof Plastinates



### Hoof SE20

---

This is a thin slice of an equine foot encased in a firm plastic casing making it ideal to have in the truck, classroom or at the stables without getting damaged



### Hoof and Lower Limb Sheet SE30

---

- U Hoof and pastern plastinate
- U A handy piece for farriers, vets and owners
- U Encased in perspex for protection



Shop online any time, any day at  
**[www.farrier-shop.com](http://www.farrier-shop.com)**

## 3D Hoof Models



Half healthy, half foundered hoof



Healthy hoof

### Hinged 3D Hoof Model - Hybrid

- Hinge at toe allows you to see inside a foundered hoof, showing rotation of the bone structures
- Great for explaining laminitis to clients, students and horse owners
- Freeze dried
- Half foundered, half "normal"

### Hinged 3D Hoof Model

- Hinged at the toe to open up displaying bones and other structures within the hoof and lower limb
- Freeze dried
- Great for farriers and vets to help with explaining hoof conditions or for riding groups, pony clubs etc
- A very valuable resource
- Made in USA



Foundered hoof

### Hinged 3D Hoof Model - Foundered

- Hinge at toe allows you to see inside a foundered hoof, showing rotation of the bone structures
- Great for explaining laminitis to clients, students and horse owners
- Freeze dried



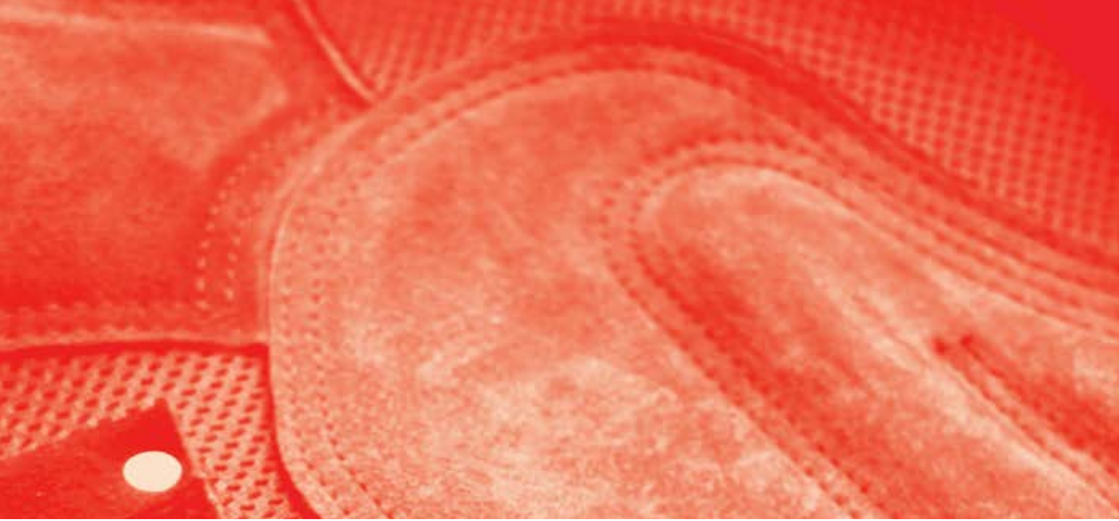

# CLOTHING



## Farrier Chaps



### Gibbins Tear-Away Hipster Chaps Long or Short Flamemaster

Combines state of the art technology in flame retardant finishing with the hardwearing and aesthetic properties of cotton rich polyester blends.

- U Provides excellent cover to the inside of legs
- U Velcro fastenings at thigh and waist
- U Waist adjustment with 2" buckle
- U Knife pocket on each leg
- U Hipster cut for added comfort

Choice of short leg to keep you protected but cool (short is shown in photo) or long leg.

Gibbins farrier chaps are made in the UK and the apron of choice for farriers all over the world.

75% Cotton 25% Polyester.



### Gibbins Wrap-Around Superthistle Long Chaps

Top of the range suede, specially designed for use by farriers. It retains its moisture and tends to leather-up with use. Strong and supple without excess weight.

- U Hipster cut
- U Excellent cover to inside of legs
- U Leg fastening with multi-position Tenax popper
- U Waist adjustment with 1.5" buckle
- U Pocket on each leg



### Superthistle Replacement Chap Patches

---

Gibbins replacement patches for superthistle chaps.



### Replacement Tenax Fastener For Gibbins Chaps

---

To replace the side fasteners on Gibbins chaps.



### Gibbins Farrier Back Pad

---

A padded leather disc with felt belt loops for distributing the weight of farrier chaps while being worn. Made in the UK by Gibbins.



### Mini Farrier Toddler Chaps

---

- Mini farrier chaps for toddlers
- Pretty darn cute and they make a great gift for any horse young family member or friend
- 13" from top to bottom



## TTM Farrier Apron

- The apron has padded thigh protection and cushioning
- Folded front for extra comfort
- Elasticated and cushioned back support
- Available in short and long
- Replacement patches also available



Burgundy



Duck brown



Grey



Camouflage



## NC Tool Cordura Chaps

- U Made from a tough and comfortable Cordura material with a cotton duck backing
- U Provides comprehensive and complete coverage of the fly area as well as below/inside the knee
- U Tough polyester web belts
- U Quick releasing leg straps
- U Heavy leather patches cover worn areas
- U Double knife holders
- U Nail magnet on the left, inside
- U Extra long
- U One size
- U Available in colours camouflage, burgundy, duck brown and grey

## Other Clothing

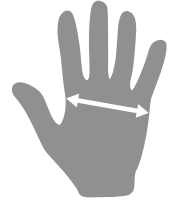

Measure in cm across the palm of your hand just below the fingers to establish your glove size.

### MacWet Gloves

- U Premium gloves for equestrianism
- U Lightweight
- U Made from Aquatec material
- U Maximum grip, comfort and sensitivity in all conditions

#### Cuff Lengths:

- U Long
- U Short

#### Colours:

- U Black
- U Navy

#### Materials:

- U Mesh: The original MacWet glove designed to aid circulation of airflow around the hand.
- U Climatec: Superb grip and sensitivity with increased comfort in cold weather.

#### Sizing availability:

	6	6.5	7	7.5	8	8.5	9	9.5	10
Micromesh Short Black			✓	✓	✓	✓	✓		
Micromesh Short Navy			✓	✓	✓	✓	✓		
Micromesh Long Black	✓	✓	✓	✓	✓	✓	✓	✓	✓
Micromesh Long Navy		✓	✓	✓	✓	✓			
Climatec Long Black	✓	✓	✓	✓	✓	✓	✓		



# ALL GRIP NO SLIP

---

**MacWet**

GLOVES



## Magnetic Wrist Strap

---

Ideal for holding horseshoe nails while you're nailing on.



## Latex Gloves

---

Ideal for working with hoof adhesive materials.

Available in S, M, L, and XL.

Sold by the box.



For a quote on international orders, contact us.

[sales@p3equestrian.com](mailto:sales@p3equestrian.com)





## Jewellery

We stock a stunning range of sterling silver jewellery that is perfect to choose from as gifts or as a treat for yourself.

### Necklaces



**Horseshoe Nail Heart  
Necklace**



**Double Nail Heart  
Necklace**



**Horseshoe Heart  
Necklace**



**Horse Hoof Necklace**



**Wavy Nail Necklace**



**Wavy Nail Necklace  
with Cubic Zirconias**



**Hoof Sole Necklace**



**Ribbon Nail Necklace**



**Snaffle Bit Necklace**

# CLOTHING



**Nail Cross Necklace**



**Nail Fish Necklace**



**Vet Caduceus Necklace**

## Bracelets



**Triple Snaffle Bit Bracelet**



**Barshoe Bracelet - Large**



**Barshoe Bracelet - Small**



**Single Snaffle Bit Bracelet**



## Rings



**Ladies Nail Ring**

---



**Ladies Shoe & Nail Ring**

---

## Earrings



**Nail Heart Earrings**

---



**Shoe Heart Earrings**

---



Shop online or from your smartphone at

**[www.farrier-shop.com](http://www.farrier-shop.com)**

# HORSE CARE





## Kevin Bacon's



### Kevin Bacon's Active Soap

---

- For treatment of itchy horses
- Repels external parasites
- 100% natural ingredients
- Applied with sponge (included)



### Lucy Diamonds Horse Shampoo 1L

---

Contains plant extracts known for their softening and protective qualities as well as gentle washing bases of mint, eucalyptus and neem.

May be used in cases of itching due to insect bites or to protect the skin after sweating.

Particularly recommended for animals with sensitive skin that are exposed to inclement weather and for frequent washing.

Its unique formula protects against the bad odours that can be caused by micro-organisms.



## Other Horse Care



### Horse Height And Weight Tape

- U Estimates the weight of ponies and horses and serves as an efficient daily conditioning guide
- U Tape measures 80" (203 cm) long
- U Shows height in hands
- U Weighs animals up to 599kg



### Animalintex

- U Poultice dressing
- U For drawing out abscesses
- U The leading choice



## To place an order

Website: [www.farrier-shop.com](http://www.farrier-shop.com)

Call: 0800 211 212

Text: 021 555 213

Email: [sales@p3equestrian.com](mailto:sales@p3equestrian.com)

Fax: 03 974 9728





Shop online at  
**www.farrier-shop.com**

**Tel (NZ):** 0800 211 212

**Tel (AU):** 1800 195 088

**Email:** [sales@p3equestrian.com](mailto:sales@p3equestrian.com)

**Address:** 115 West Coast Road,  
Yaldhurst,  
Christchurch 7676,  
New Zealand



[www.facebook.com/farriershop](http://www.facebook.com/farriershop)



[www.twitter.com/p3equestrian](http://www.twitter.com/p3equestrian)



[www.instagram.com/farrier\\_shop](http://www.instagram.com/farrier_shop)



[www.farriery.com](http://www.farriery.com)

